



User Manual

English

versaCount™

Part-No. 2 772 058 englisch; 04/2010



Table of Contents

| | | |
|----------|---|-----------|
| 1 | General Information | 7 |
| 1.1 | Introduction | 7 |
| 1.2 | Explanation of symbols | 9 |
| 1.3 | Limitation of Liability | 10 |
| 1.4 | Copyright protection | 11 |
| 1.5 | Warranty | 11 |
| 2 | Safety | 12 |
| 2.1 | Intended Use | 12 |
| 2.2 | Assembly, connecting, programming | 13 |
| 2.3 | Responsibilities of the machine/plant manufacturer and operator | 16 |
| 2.4 | Operator requirements | 17 |
| 2.5 | Hazards | 18 |
| 2.6 | Safety devices | 20 |
| 3 | Setup and Operation | 21 |
| 3.1 | Dimension Sheet / Multifunction Counter Installation | 22 |
| 3.2 | Connecting the Multifunction Counter | 23 |
| 3.3 | Display | 28 |
| 3.4 | Key functions | 30 |

Table of Contents

| | | |
|----------|---|-----------|
| 3.5 | Overview of Operating Elements | 33 |
| 3.6 | Programming the Standard Function | 34 |
| 3.7 | Programming the Function Codes | 36 |
| 3.8 | Programming the Preset Modes | 37 |
| 3.9 | The Prescaler Programming | 39 |
| 3.10 | Programming the (User) Times | 40 |
| 3.11 | Output of Device ID | 42 |
| 3.12 | Adjusting the backlight | 43 |
| 4 | General Functions of the Multifunctional Counter | 44 |
| 5 | Pulse Counter | 51 |
| 5.1 | Description of Pulse Counter | 51 |
| 5.2 | Signal diagrams – counter input signals | 53 |
| 5.3 | Signal diagrams – counter output signals | 56 |
| 5.4 | Programming the counter function codes | 60 |
| 6 | Tachometer | 75 |
| 6.1 | Tachometer description | 75 |
| 6.2 | Signal diagrams – tachometer | 77 |
| 6.3 | Programming the tachometer function codes | 78 |

Table of Contents

| | | |
|-----------|--|------------|
| 7 | Timer | 88 |
| 7.1 | Timer description | 88 |
| 7.2 | Signal diagram – timer input signals | 91 |
| 7.3 | Signal diagrams – timer output signals | 94 |
| 7.4 | Programming the timer function codes | 94 |
| 8 | Shift Counter | 111 |
| 8.1 | Shift counter description | 111 |
| 8.2 | Scroll between Total Sum and Partial Sums | 112 |
| 8.3 | Signal diagrams – shift counter input signals | 113 |
| 8.4 | Signal diagrams – shift counter output signals | 115 |
| 8.5 | Programming the shift-counter function codes | 116 |
| 9 | Batch Counter | 131 |
| 9.1 | Batch counter description | 131 |
| 9.2 | Signal diagrams – batch counter | 133 |
| 9.3 | Programming the batch counter function codes | 134 |
| 10 | Technical Data | 150 |
| 11 | Transport, Packaging, Storage | 157 |

Table of Contents

| | | |
|----|-----------------------------|-----|
| 12 | Maintenance and cleaning | 157 |
| 13 | Trouble shooting | 158 |
| 14 | Spare parts | 160 |
| 15 | Dismantling and disposal | 160 |
| 16 | Model numbers | 161 |
| 17 | Accessories and spare parts | 162 |

General Information

1 General Information

1.1 Introduction

These operating instructions provide important information about the operation and handling of the multifunctional counter. To ensure safe operation it is vital that the safety information and instructions be strictly observed.

For Versacount XP models please reference the amendment 2 772 069 in addition to these instructions.

The multifunction counter has been designed for industrial use and for installation in machinery or industrial plants.

The party responsible for the end use/application has the ultimate responsibility to ensure that the multifunction counter is installed and set-up in accordance with the operating guidelines set forth in this manual.

All local regulations applicable to safety and accident prevention must be adhered to for the installation and operation of this multifunction counter.

Please read these instructions before installing or operating the multifunction counter.

These operating instructions are an integral part of the product and must be maintained in the direct vicinity of the multifunction counter or in a place that is readily accessible.

General Information

These operating instructions contain important information concerning the installation, programming and operation the multifunction counter.

Description of the programming sequence:

- Programming of the basic functions
- Programming of the function codes
- Programming of the user times
- Programming of the prescaler
- Programming of the presets

Before commissioning the multifunction counter, consider locking-out functions not required for regular operation.



The executed programming functions must be documented.

General Information

1.2 Explanation of symbols

The warnings in these operating instructions are designated by symbols and words that indicate the severity of a safety hazard.

These warnings must be observed at all times and appropriate actions must be taken at all times to prevent accidents, damage, personal injury or death.



Danger!

This warning indicates a direct safety hazard, which may lead to serious injuries or even death if preventative action is not taken.



Warning!

This warning indicates a possible safety hazard, which may lead to serious injuries or even death if preventative action is not taken.



Caution!

This warning indicates a possible safety hazard, which may lead to minor damage or injuries if preventative action is not taken.

General Information



Note!

This symbol indicates a potentially hazardous situation, which may lead to damage to property or to the environment if preventative action is not taken.



Tips and recommendations

This symbol is used to point out to useful tips, recommendations and information for optimal operation.

1.3 Limitation of Liability

The information contained in these operating instructions was gathered in accordance with applicable standards and regulations.

The manufacturer shall not assume any liability for damage caused by:

- Non-adherence to the operating instructions
- Improper use
- Employment of unskilled or untrained personnel
- Modifications or changes to the multifunction counter
- Opening of the multifunction counter

We reserve the right to make changes or modifications to the design, specifications or options without notice.

General Information

The actual product may not appear exactly as illustrated in this manual.

1.4 Copyright protection

The operating instructions must be treated confidentially and used exclusively by the personnel responsible for the setup, maintenance, repair and operation of the counter. Disclosure of these operating instructions to any third parties is not permissible without the prior written consent of the manufacturer.



The data and information stated here, including text, drawings, images and other illustrations, are protected by copyright laws and subject to industrial property rights. Any misuse of such information will be subject to prosecution.

1.5 Warranty

Our standard warranty is available on our website at www.veeder-rootcounters.com.

2 Safety

This section provides an overview of important consideration to ensure the safe and trouble-free operation of your counter. Non-adherence to these instructions may result in serious injury or death.

2.1 Intended Use

The multifunctional counter is exclusively designed and constructed for the intended use and purposes described herein.

The multifunctional counter serves together with a corresponding sensor for the counting of pieces, lengths, flow rates, velocities and times, as well as for the controlling and monitoring of machinery and equipment by sending and receiving control signals.



Warning!

Safety hazards due to improper use!

Using the multifunction counter for any purposes other than those described may cause hazardous situations.

Claims for damages resulting from any kind of misuse shall be expressly excluded.

2.2 Assembly, connection, programming

The multifunction counter is built and tested in accordance with IEC/EN 61010-1, Protection Class II – Safety Measures for Electronic Measuring Equipment. They have left the factory in a condition that is in compliance with all safety-relevant requirements. In order to maintain this condition and ensure operational safety, the User is required to observe the safety notes and warnings in these operating instructions!



Danger!

Risk of safety hazards due to incorrect/faulty assembly and connection.

- The maximum operating voltages must not be exceeded!
- 12 – 24VDC and 24VAC multifunction counters must be operated at safety extra-low voltages (SELV) and under potential-compensated conditions in order to prevent hazardous shock.
- An external fuse must be provided to protect the multifunction counter (see Chapter 10, Technical Data).
- Installation and assembly shall be carried out by skilled and trained electricians only.
- Do not connect or disconnect a multifunction counter while it is in contact with a live current. Always disconnect the main power supply before connecting or disconnecting the multifunction counter.
- All terminals should be properly insulated to prevent accidental contact.

Safety

- To prevent accidental shock or injury, ensure that live conductors are securely connected to the terminals and properly insulated.
- The rules and regulations set forth by the local electricity providers have to be observed.
- Do not establish any connections with non-allocated (NC) terminals.
- Multifunction counters may only be operated when properly installed.
- If safe operation is impaired, make the multifunction counter inoperable and secure it against inadvertent operation.
- Scope of applications: industrial processes and controls. Overvoltage across the terminals must be limited to the values specified in overvoltage category II.
- The installation and wiring has considerable impact on the electromagnetic properties of the multifunction counter. Therefore, electromagnetic compatibility of the entire application must be ensured during the installation.
- In areas presenting the risk of ESD (electrostatic discharge), use ESD-protected plugs and switches.
- If the functions "prescaler input", "preset input" and "key reset" are not allowed to be used by the machine/plant operator, access to these functions must be locked. Depending on the application, non-permissible input may impair the safe operation and function.

Safety



Danger!

The party responsible for the commissioning of the multifunction counter must take precautions to ensure the safe operation of the device.

- The party responsible for the commissioning of the multifunction counter is responsible for the preparation of operating instructions including:
 - Description of functions according to the programming of the multifunction counter;
 - Description of the settings to be adjusted by the machine/plant operator;
 - Information concerning the occupational safety requirements and possible hazards arising from the operation of the machine/plant.

2.3 Responsibilities of the machine/plant manufacturer and operator

Multifunctional counters are designed for installation and use in machines/plants. Therefore, the manufacturer and operator of the machine/plant are subject to the legal obligations concerning occupational safety and health.

In particular:

- The machine/plant manufacturer shall be obligated to ensure that all the requirements mentioned in section 2.2 be adhered to during the assembly, connection and programming.
- The operator shall obtain all required information regarding applicable occupational safety rules. In addition, the operator shall be obligated to prepare a risk assessment of possible hazards that may arise at the place of operation. This risk assessment shall be documented in the form of operating instructions for the machine/plant.
- The machine/plant manufacturer and operator are responsible for regularly checking local occupational safety and health requirements and, if required, making appropriate revisions to the application instructions.
- The operator shall ensure that all staff members who are involved in the machine/plant operation have read and fully understood these instructions. Moreover, the operator shall be obligated to train the operating personnel at regular intervals and inform them about any potential hazards.

- The owner shall ensure that the operation, maintenance and repair of the machine/plant is exclusively carried out by skilled and trained personnel.

2.4 Operator requirements



Warning:

**Risk of personal injury is operated by unqualified individuals!
Improper handling may cause severe personal injuries and damage to property.**

- Actions requiring special skills must be carried out only by trained personnel as designated in these instructions.
- Keep unqualified/untrained personnel away from hazard areas.

The following staff qualification requirements have been defined for the various scopes of activities:

- **Instructed personnel**
These persons have been instructed by the operator with regard to the tasks assigned and the potential hazards caused by improper handling.
- **Skilled personnel**
Due to their educational and professional skills, know-how and experience, as well as their knowledge of relevant regulations, these persons are capable of executing their assigned tasks, safely and competently.
- **Skilled and trained electricians**
Due to their educational and professional skills, know-how and experience, and their knowledge of electrical codes, these persons are capable of executing electrical work safely and competently.

2.5 Hazards

This section indicates certain risks, which may arise as a result of improper installation or application.

The safety information and warnings in these instructions must be observed in order to reduce the risk of hazards or injury.



Danger!

Lethal hazard of electric shock!

Any contact with live currents presents a direct lethal hazard.

Damages to the insulation or individual components present a potential lethal hazard.

- **In the event of damage to the insulation, immediately disconnect the power supply and initiate the appropriate repair work.**
- **All electrical work must be carried out by skilled and trained electricians.**
- **Before commencing your work on the electrical system, disconnect it from the main power supply and check that it no longer carries any live currents.**
- **Prior to conducting any maintenance, cleaning or repair work, disconnect the main power supply and secure it against inadvertent engagement.**
- **Do not short-circuit or bypass/jump fuses.**

Safety

2.6 Safety devices



Warning! Lethal hazard by non-functional or non-existent safety devices!
Safety devices must be installed to ensure operational safety.

The multifunction counter does not include any installed safety devices.
These safety devices must be installed externally.

Protect the electrical supply of the multifunction counter by means of external fuses (see Chapter 10, Technical Data).

Whether or not additional safety devices (e.g. emergency-off buttons) have to be provided depends on the application and construction of the machine or plant.

The machine/plant manufacturer shall be responsible for providing such additional safety devices in according with their own risk assessment and applicable local laws and regulations.

3 Setup and Operation

3 Setup and Operation

- 1 Display
- 2 Operating keys
- 3 Flat gasket
- 4 Bracket
- 5 Enclosure
- 6 Plug for DC or sensor supply; Electronic inputs and outputs
- 7 Connection terminal AC supply and relay contacts
- 8 Circuit diagram



3 Setup and Operation

3.1 Dimension Sheet / Installation of Multifunction Counter

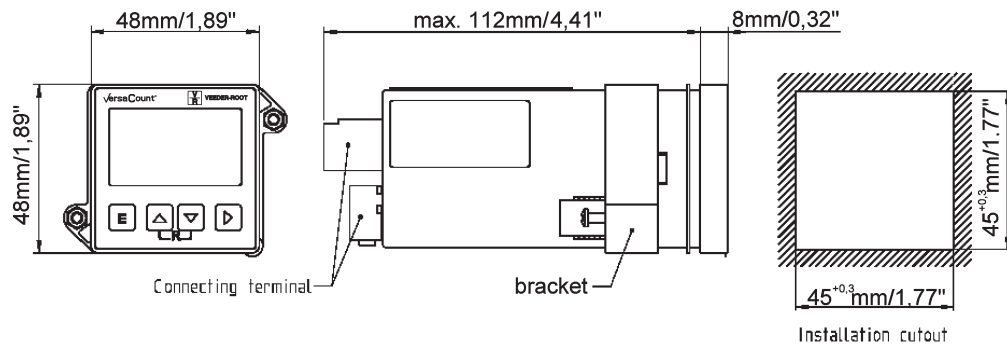

3 Setup and Operation

3.2 Connecting the Multifunction Counter

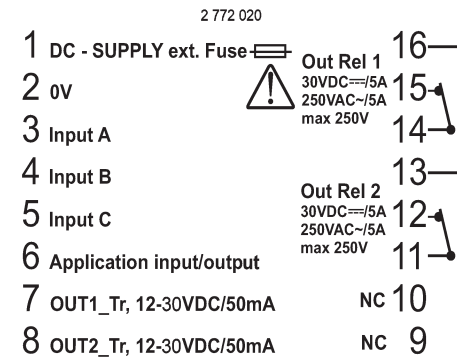

VDC 2 relays / 2 transistors

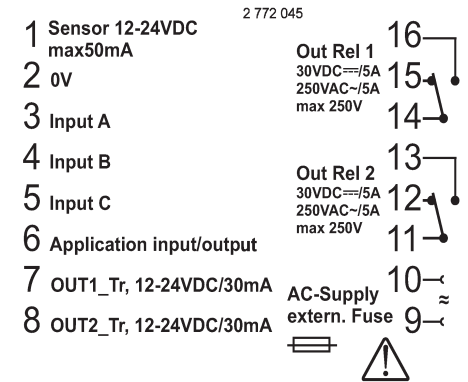

VAC 2 relays / 2 transistors

3 Setup and Operation

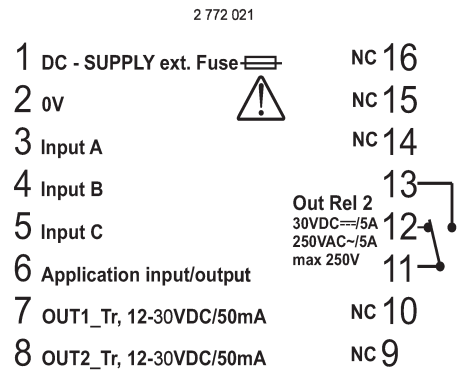

VDC 1 relays / 2 transistors

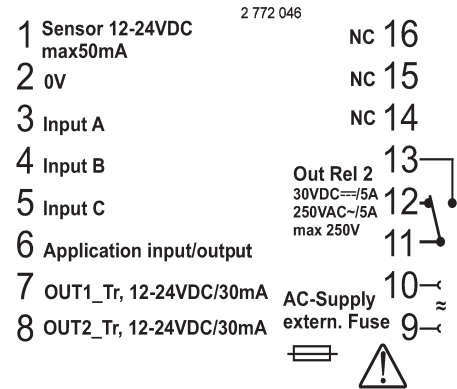

VAC transformer 1 Relays / 2 transistors

3 Setup and Operation

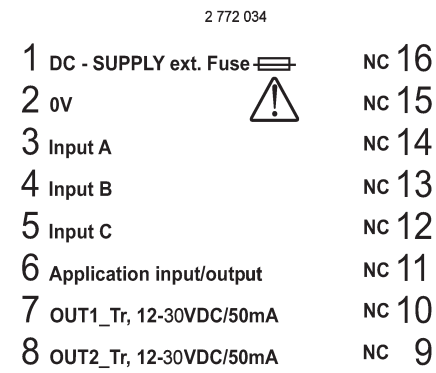

VDC 2 transistors

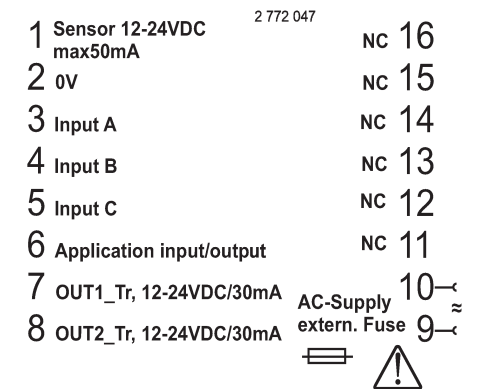

VAC 2 transistors

3 Setup and Operation

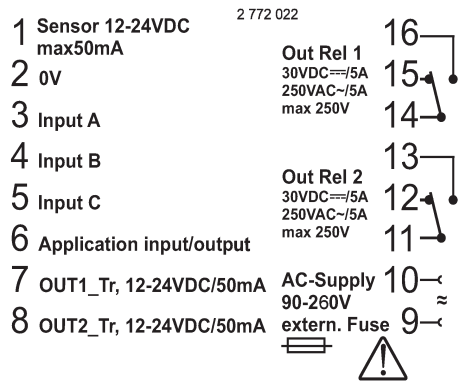

VAC switching power supply 2 relays / 2 transistors

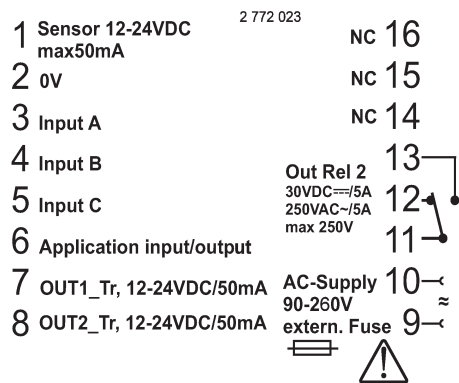

VAC switching power supply 1 relay / 2 transistors

3 Setup and Operation

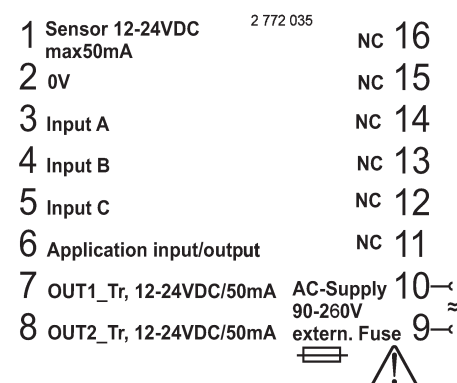

VAC switching power supply 2 transistors

The plug has to be disconnected from the counter before the cables are fastened by means of screws or screw-type terminals.

Do not connect the encoder to a direct current line voltage without protective circuit for EMC. For cable lengths > 30 m/100 ft a protective circuit is always required!

When programming the input level to TTL an additional protective circuit is required.

We recommend installation in a metal, grounded panel.

3 Setup and Operation

For DC-Versions:

When switching on the device in PNP-Mode, a short signal is applied to inputs A,B,C and the application input.

To suppress the pulse in TTL-Mode, each input should be connected to a 10 kOhm resistor and the 0V.

When switching on the device a short signal is applied to the application output.

To suppress this pulses connect a resistor of 10 kOhm / 0.225 W to the 0 V and the application-output.

3.3 Display

After powering on, all characters are illuminated for approx. 2 seconds; then the display changes over to the Display or Programming Mode.

The display is available in four different versions:

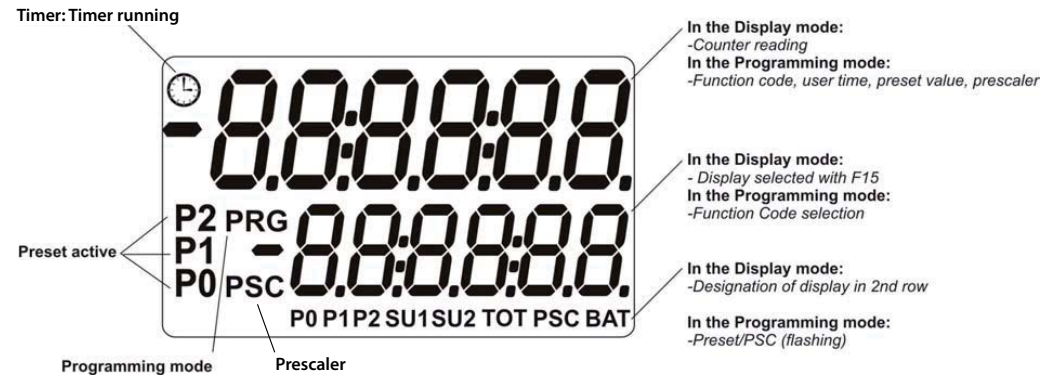

- Transflective Positive: black figures on background
- Transmissive Negative: white figures on black background
- Transmissive red: red figures on black background
- Transmissive green: green figures on black background

3 Setup and Operation







3 Setup and Operation

3.4 Key functions

| | | | |
|---|---|---|---|
|  |  |  |  |
| Enter - Key | UP - Key | DOWN - Key | SHIFT - Key |

Programming

If pressed together with POWER ON (keep keys pressed and switch on the device)

| | |
|--|--|
|  | Selects standard functions |
|  | Sets function codes |
|  | Selects ID data (Model number, manufacturing date, serial number,...) |
|  | Sets User Times |

3 Setup and Operation







During the Programming of Function Codes

| | |
|---|--|
|  | Display function code Switches between function code text and function code number |
|---|--|

During Operation

| | |
|---|----------------|
|  | Sets reset |
|  | Sets preset 0 |
|  | Sets preset 1 |
|  | Sets preset 2 |
|  | Sets prescaler |

3 Setup and Operation

| Additional function for shift and batch counters | |
|--|---|
|  | Switches between total sum and partial sums and/or count value and totalizer or batch counter |
| Additional functions for timers | |
|  | Timer start (If enabled with function code F15) |
|  | Timer stop (If enabled with function code F15) |
| Additional functions backlight versions | |
|  | Go to the adjustment menu (hold for 5 seconds) |
|  +  | Adjust the intensity (brighter or darker) |
|  | Save and go back to display mode (press within 15 seconds) |

3 Setup and Operation

3.5 Overview of Operating Elements

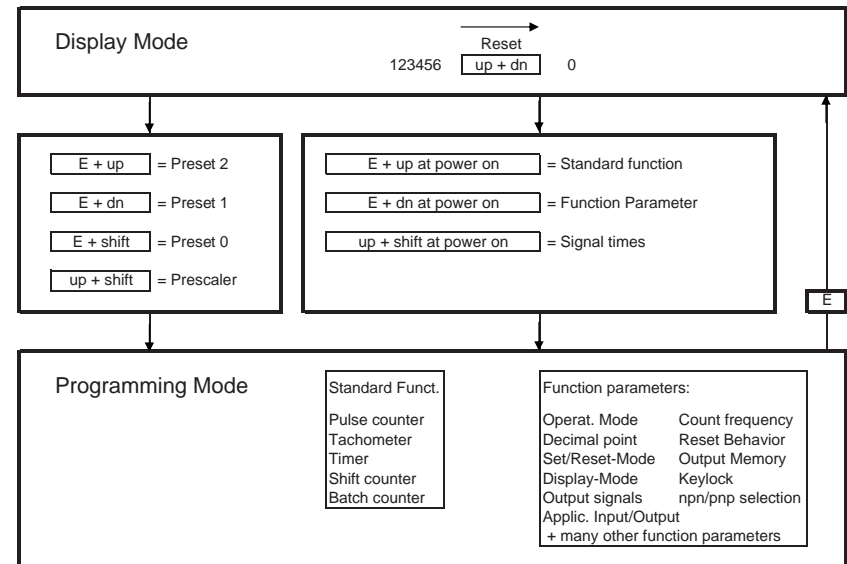





3 Setup and Operation

3.6 Programming the Standard Function

The device described here is a multifunction counter, which can be programmed for a variety of functions and applications, i.e. pulse counter, tachometer, timer, shift counter or batch counter. The first step is to set the standard function (the default factory setting is "pulse counter").

Now continue with the programming of the function codes (Chapters 5-9) or User Times (Chapter 3.10)

| | | |
|---|--|---|
| Enter Programming mode | Change function setting: | Save, return to counter operation |
|  +  |  or  |  |
| Keep pressed and switch Power on simultaneously | press | press |





3 Setup and Operation

| Function code | Display Row 1 | Function | No. | Display Row 2 | |
|---------------|---------------|------------------------|-----|---------------|---------------|
| Fn | FUNCEE | Sets Standard Function | 0* | PULSCE | Pulse Counter |
| | | | 1 | TACHOE | Tachometer |
| | | | 2 | TIMER | Timer |
| | | | 3 | SHIFCE | Shift Counter |
| | | | 4 | BATCHC | Batch Counter |

3 Setup and Operation

3.7 Programming the Function Codes

The function codes (system parameters) are used to program the function of the inputs and outputs and the device itself. The selection options are described in detail in Chapters 5 to 9.

| Enter Programming mode | Change function setting | Save and change to next function code | Save and change to counter operation |
|---|---|---|---|
|  |  |  |  |
| Keep pressed and switch Power on simultaneously | press | press | press |

Change between Text Display and Numerical Display



In the function code Programming Mode, the first row shows the name of the function code in the form of text (7-segment display). The second row shows the selectable option in a text form. By simultaneously pressing the Up and Down buttons, the display in the first row changes to a numerical display; after pressing these buttons once again, the display in the second row also changes to a numerical display. Pressing these buttons for a third time reverts both rows back to the text display.

3 Setup and Operation



Attention: With each change among text and numeric display, the currently selected function code will return to the factory default setting and may have to be readjusted.

The factory default setting is designated with an asterix *.

3.8 Programming the Preset Values

By simultaneously pressing the E + Up, E + Down or E + Shift key you can change to the Preset programming mode:

Use the shift key in the programming mode to change a setting position. The selected position will start to flash. Use the shift key again to move one position to the right. Then use the UP or Down key to increment or decrement the position by 1.

Rule for the 6th position: The change from 9 to 0 or 0 to 9 is indicated by a changing prefix.

Use the E key to leave the programming mode and return to the display mode. Your entries will be saved.

On leaving the programming mode, the presets are tested for attainability and recalculated, if necessary, because not all the values may be attained at a prescaler value of >1. The presetting is then rounded to the closest attainable value.

3 Setup and Operation

If no key is pressed for more than 16 seconds in the programming mode, the counter will automatically return to the display mode. In this case, however, no entries will be saved except the last value saved with the E-key.

Set the preset value to 0 by pressing Up and Down keys simultaneously.

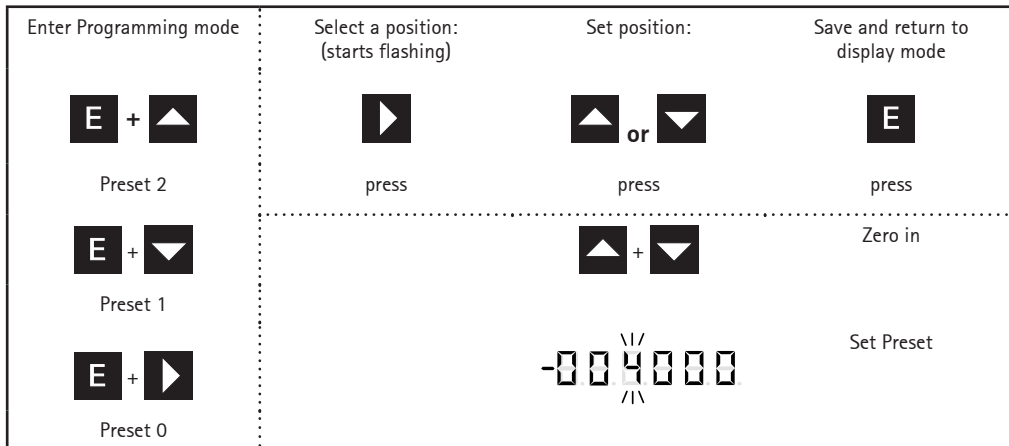

3 Setup and Operation

3.9 Prescaler programming

By pressing the Up + Shift keys simultaneously you can change to the Prescaler Programming Mode.

In the Programming mode, the position to be changed is selected by means of the shift key. The selected position will start flashing. Use the shift key again to move by one position to the right. Then use the UP or Down key to increment or decrement the position by 1. It is not possible to save a value of 00.0000. In this case the system will save 01.0000.

Use the E key to leave the programming mode and return to the display mode. Your entries will be saved.

On leaving the programming mode, all the presets are recalculated because not all the values may be attained with a prescaler value of >1. Therefore, the presets have to be checked and corrected as necessary after setting the prescaler.

If no key is pressed for more than 16 seconds in the programming mode, the counter will automatically return to the display mode. In this case, no entries will be saved except the last value saved with the E-key.

Press the Up and Down keys simultaneously to set the prescaler to 01.0000.

3 Setup and Operation

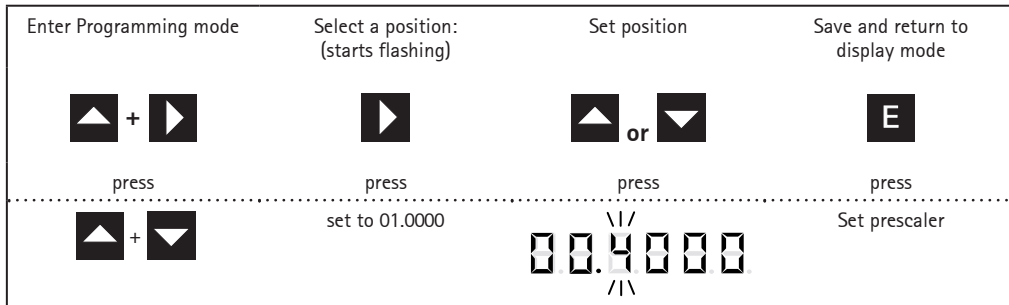



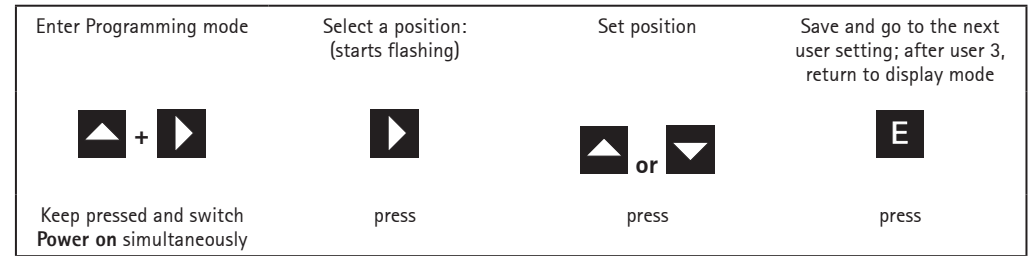

3.10 Programming the user times

For programming the signal time for monostable (timed) output signals, 9 fixed signal times between 0.02 s and 10 s are available. In addition, three different signal times between 0.01 s and 599.99 s can be set by the user. The outputs are deactivated if the setting is 0.00 s.

3 Setup and Operation





| Function code | Display Row 1 | Function | No. | Display Row 2 |
|---------------|---|-----------------------|-----|---|
| Fn |  | Sets the Signal Times | 0* |  Signal time 1 |
| | | | 1 |  Signal time 2 |
| | | | 2 |  Signal time 3 |

3 Setup and Operation

3.11 Output of Device ID

This function is used to retrieve Device ID data, e.g. model numbers and various manufacturing information

| | | |
|---|---|---|
| <p>Enter Output mode</p>  <p>Keep pressed and switch Power on simultaneously</p> | <p>Change to the next output</p>  <p>press</p> | <p>Return to counter operation</p>  <p>press</p> |
|---|---|---|

| Display row 1 | Display row 2 |
|---------------|--------------------|
| 888800 | Model number |
| 088800 | Manufacturing date |
| 500000 | Serial number |
| 500000 | Software number |
| 500000 | Software release |

3 Setup and Operation

3.12 Adjusting the intensity of the backlight



For counters that come with a backlight you have the ability to adjust the intensity.

To adjust the backlight, press SHIFT for more than 5 seconds. The display then shows:

888800HE
088800

By pressing the UP or DOWN key the display gets brighter or darker.

If the E-button is pressed within 15 seconds, you go back to the normal counter display and the adjusted setting is saved. If the E-button is not pressed within 15 seconds, you will go back automatically to the normal counter menu without saving any changes.

| | | |
|---|---|---|
| <p>Go to the adjustment menu</p>  <p>press > 5 s</p> | <p>Adjust intensity</p>  <p>press</p> | <p>Save and go back to display mode</p>  <p>press within 15 s</p> |
|---|---|---|

4 General Functions of the Multifunction Counter

The following description is applicable for all com settings. Special functions and configurations can be found in the appropriate chapters of this manual.

| | |
|--|--|
| Factory setting (Defaults) | Sets all the function codes to the default factory settings, i.e. all codes designated with *. |
| Prescaler (pulse metering factor): [PSC] | <p>The "Prescaler" is a multiplier. Each input pulse is multiplied by the adjustment factor. The display shows integers only. After a reset the counter is completely reset to 0; this also includes the non-visible value of < 1.</p> <p>At a prescaler of >1 not all the values are selectable. If invalid Preset values are selected, the counter will round them up to the next possible value.</p> <p>Example: PSC 5 cannot select (reach) Preset value 7. In this case, the counter automatically changes the Preset value to 10.</p> <p>If the Prescaler is changed, this may also affect the Preset values, which would have to be changed accordingly.</p> <p>Adjusting range 0.0001 to 99.9999</p> |

4 General Functions of the Multifunction Counter

| | |
|------------------------------------|---|
| | <p>The Prescaler is used, for example, to convert counter pulses into meaningful units, to adapt the units of measurements (e.g. cm-pulses to inch-pulses), or to compensate for worn out measuring wheels.</p> <p>Formula: $PSC = \text{Desired/nominal display} / \text{number of pulses}$</p> <p>Example: Flowmeter 173 pulses per 100 liters; display in liters $PSC = 100 / 173 = 0.5780$</p> <p>Example: 1 pulse per cm; display in inch $PSC = 1 / 2.54 = 0.3937$</p> <p>Attention: This is only valid for counters and tachometers. For timers please refer to chapter 7.</p> |
| 2nd row display: | The display of the 2nd row can be programmed as follows: Preset 2 (P2), Preset 1 (P1), Preset 0 (P0), Prescaler, Batch counter, totalizer or partial sums (shift counter) |
| Counter and control inputs: | The counter is fitted with 3 counter and control inputs and an application input (see below). These inputs are assigned various counter or control functions by means of function code settings. |
| Input logic: | The input logic can be programmed to NPN or PNP, each at the 8V-level or TTL level; see Chapter 10 for the switching threshold. |

4 General Functions of the Multifunction Counter

| | |
|-------------------|--|
| Reset/Set: | <p>Manual setting via keys (lockable) Electronic setting via control input (and/or application input) Automatic programming after reaching the main Preselection Programmable Power-On Reset</p> <p>Depending on the function code the counter is: 1) Reset: reset to 0 P2 is the main Preset (preselect) value During unidirectional counting the counter will add up.</p> <p>or</p> <p>2) Set: reset to P2 Signal 2 at 0 - Output 2 at 0 During unidirectional counting the counter will subtract.</p> <p>For time counting, batch counting or shift counting, it is possible to reset partial sums or the total sum, batch counter or second totalizer individually or at the same time via the application input. Independently the counter can be reset to Preset value 0 via the application input (see below).</p> <p>Exception: Tachometers do not have a reset/set function</p> |
|-------------------|--|

4 General Functions of the Multifunction Counter

| | |
|------------------------------|--|
| Static/dynamic reset: | <p>Static reset: Reset over the entire pulse width of the reset pulse Dynamic reset: Reset via the active edge; thereafter, counter operation is possible independently of the pulse width of the reset pulse.</p> <p>Exception: Tachometers do not have a reset/set function</p> |
| Teach input: | Using the Teach Input (application input) the counter status is imported in Preset 2. |
| Decimal Point: | <p>The decimal point is only an optical reading assistance on the display and does not change the value. For example, for a value of 1 pulse per cm, the setting 0.00 makes it easier to read the value in m and cm.</p> <p>Exception: This does not apply to tachometers and timers. Please refer to Chapters 6 and 7.</p> |

4 General description of the multifunction counter

| | |
|------------------------------------|--|
| Input damping (Attenuation) | <p>The inputs A and B are limited to 60 kHz. The Application Input is limited to 6 kHz.</p> <p>Following maximum input frequencies are not to be exceeded:</p> <p>Quadrature x1: A and B each 30 kHz (TTL 15 kHz) Quadrature x2: A and B each 30 kHz (TTL 15 kHz) Quadrature x4: A and B each 15 kHz (TTL 15 kHz) Unidirectional counting and directional input: Input A 60 kHz (TTL 15 kHz) Differential counting, summation (totalizing): Input A + B 60 kHz (TTL 15 kHz)</p> <p>When the application input is used as an additional count input, the above mentioned input frequencies have to be reduced by the frequency of the application input.</p> <p>If mechanical contacts are triggered (i.e. relays, switches, Reed contacts, etc.), the input frequency has to be damped (attenuated) to 30 Hz, so as to filter out bounce pulses. If damping to 30 Hz is selected, all inputs can be used at 30 Hz.</p> <p>To reach these values the amplitude thresholds are to be held. (See technical data - chapter 10)</p> |
|------------------------------------|--|

4 General Functions of the Multifunction Counter

| | |
|----------------------------------|--|
| Signals: | <p>P1 and P2 are available as relay changeover contacts and electronic output signals (PNP). P0 is available as an electronic output signal across the application output (PNP).</p> <p>If a signal is active, this will be shown on the LCD display. Optionally, the multifunctional counter can be set to have the display flash if one or all the preset values are active.</p> <p>This is also valid for Preset 0 (if no output has been assigned).</p> |
| Signal time: | <p>1) bistable (latching): Cleared by electronic or manual reset. P 0 + P 1= bistable (latching) – additionally cleared by signal 2 Attention: Signal 2 must not be bistable (latching) for automatic reset.</p> <p>2) monostable (timed): Up to 9 fixed signal times are available between 0.02s and 10s. In addition, user times can be programmed between 0.01s to 599.99s.</p> <p>3) Range signals: active as long as the counter reading is within the adjusted range.</p> |
| Signals active on/off | <p>During normal operation the relay is energized if the signal is active. This behavior can also be inverted (also applicable to the transistor outputs).</p> |
| Application input/output: | <p>Depending on the standard function, up to 11 (eleven) functions can be assigned to the application input/output. Note, however, that only one of these functions can be selected. Further details are given in the Function Code Section (5.4).</p> |

4 General Functions of the Multifunction Counter

| | |
|--------------------------------------|---|
| Application – Set to preset 0 | <p>Programs the application input to act as a Set Input. The counter is set to Preset 0, independently of the reset via input C or the keyboard.</p> <p>This function is not available for tachometers.</p> |
| Application keylock: | <p>All keyboard functions can be locked individually (Reset, P 0, P 1, P 2, Prescaler)</p> <p>Lock mode: release after 10s, complete keylock or keylock depending on keylock input (application input)</p> |

 **After setting up the system, lock all the keyboard functions you do not want to be changed by the user.**

5 Pulse counter

5.1 Description of the Pulse Counter

(Supplementing the General Functions in Chapter 4)

| | |
|--|--|
| Counter mode | <p>The following counter modes can be selected: Unidirectional counting, adding or subtracting; Unidirectional counting with directional input; Differential counting, summation (totalizing) or Quadrature x1; x2 or x4.</p> |
| Output signals mode of operation: | <p>1) coincidence signal: The counter operates in the coincidence mode, i.e. output signals are activated after reaching the Preset value for the programmed period of time.</p> <p>2) Trail: P2 and P0 are under coincidence operation; they operate as described in item A. P1 is the trail. P1 is not absolute to 0, but relative to P2.</p> <p>If the setting is F8=1, the following will apply: Signal 1 is returned at $P2 - P1$ Example: P2=1000, P1=200, Signal 1 at 800; If P1 is negative: P2=1000, P1=(-200), Signal 1 at 1200</p> <p>If the setting is F8=2, the following will be applicable: Signal 1 is returned at $P2 +$ and $- P1$ (Example: P2=1000, P1=200, Signal 1 at 800 or/and 1200)</p> <p>3) range signal: P1 and P2 are range signals: Signal 1 is active at a counter reading $< P1$ and Signal 2 is active at a counter reading $> P2$</p> |

5 Pulse counter

| | |
|---|--|
| Intermediate cut: | Depending on the application it may become necessary to isolate the main signal during the reset, e.g. when the first material lengths or certain lengths showing material defects have to be cut on length-cutting systems. |
| Additional totalizer (summation counter) | The additional totalizer sums up all values even if the main counter is continually reset. The shift key can be used to switch between the counter reading and the total sum. The totalizer can only be reset manually. To do this, select the total sum from the first row; then press the reset keys. |
| Prescaler Output PSC-out: | The prescaler output is an application output. With each increase of the counter reading the number of output pulses corresponds to the respective number of increments. The pulse length of the prescaler output corresponds to a frequency of 500 Hz. When using the prescaler output the max. count frequency is: $F_{max} = 500 / PSC$. So it is possible that the maximum input frequency can not be reached. |
| Application counter input add / sub | The application input may be assigned to the Count Up or Count Down function. This is a counter input, which is available in addition to the counter mode adjusted with F1. |
| Application Latch/Reset | Latch/Reset is an application input. If the counter is reset via the application input, the counter reading is held constant. The counter continues to remain fully functional and operates in the background mode. During the next reset the current (updated) value will be shown on the display. |

5 Pulse counter

5.2 Signal diagrams input signals (PNP-Logic)

Unidirectional counting ($F1 = C G r$) = 0

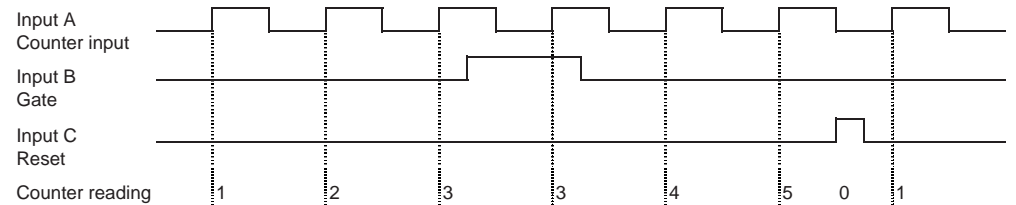

Directional input ($F1 = C d r$) = 1

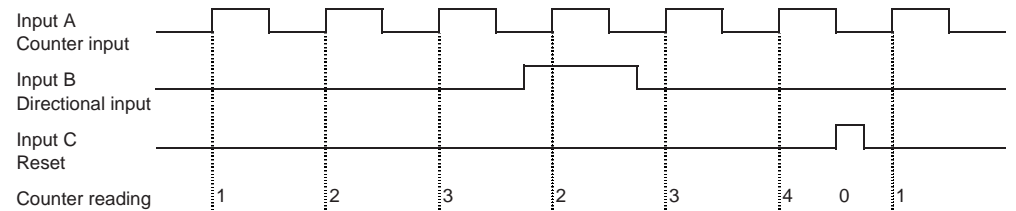

5 Pulse counter

Differential input (F1= A S r) = 3

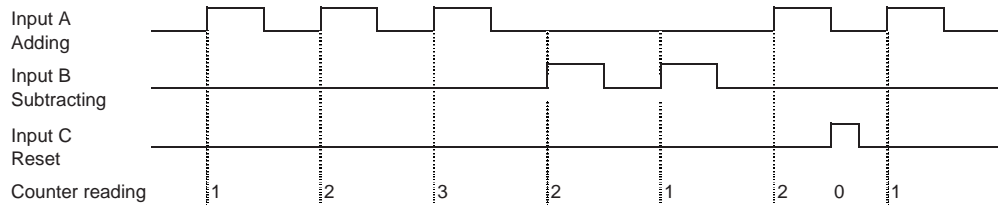

Summation (totalizer) input (F1= A A r) = 5

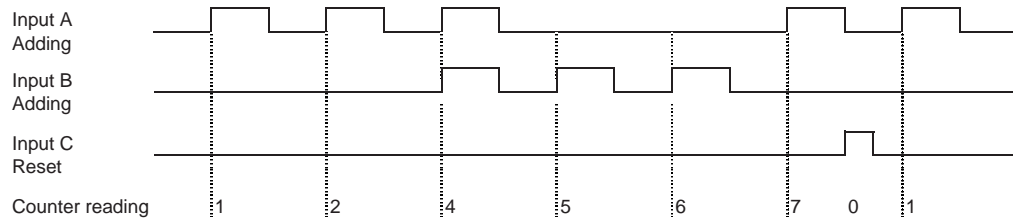

5 Pulse counter

Phase discriminator (F1 = QUAd r) = 6

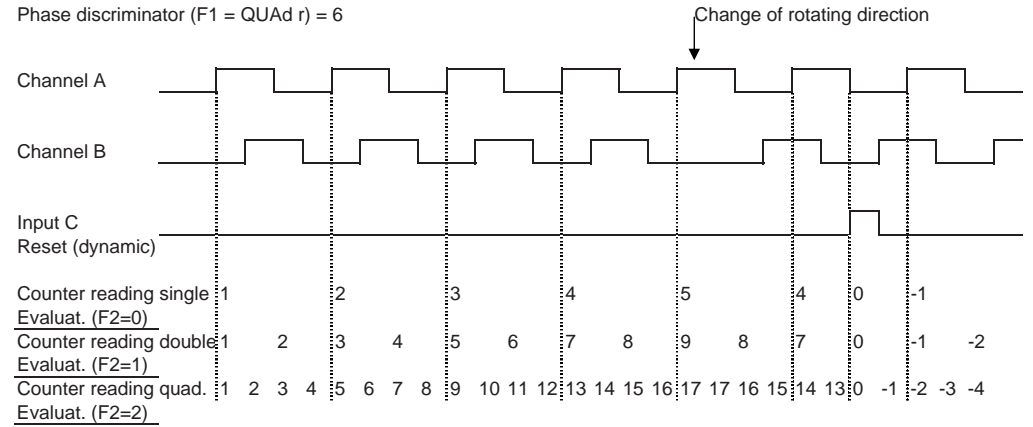

5 Pulse counter

5.3 Signal diagrams - Output signals

Output signals monostable (timed)
 Coincidence signals P0 (F10), P1 (F11), P2 (F12) monostable (timed)

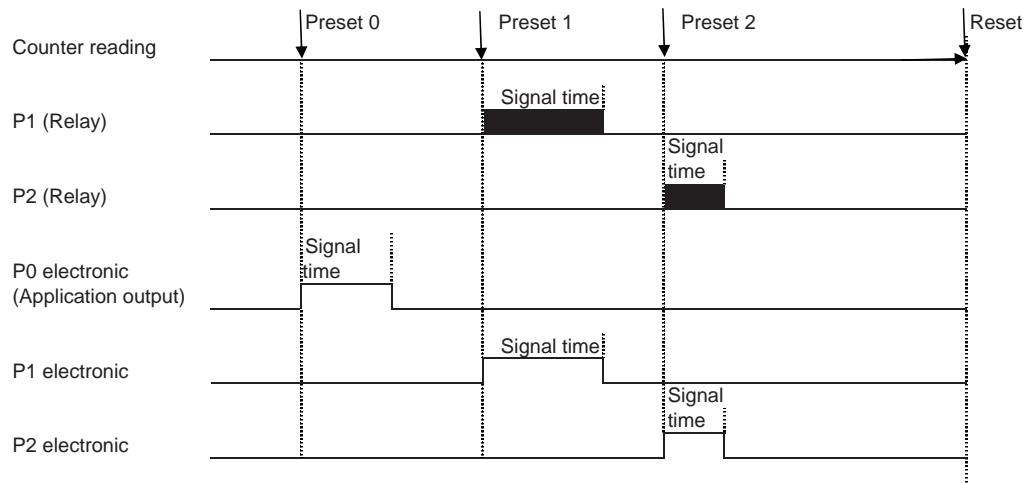





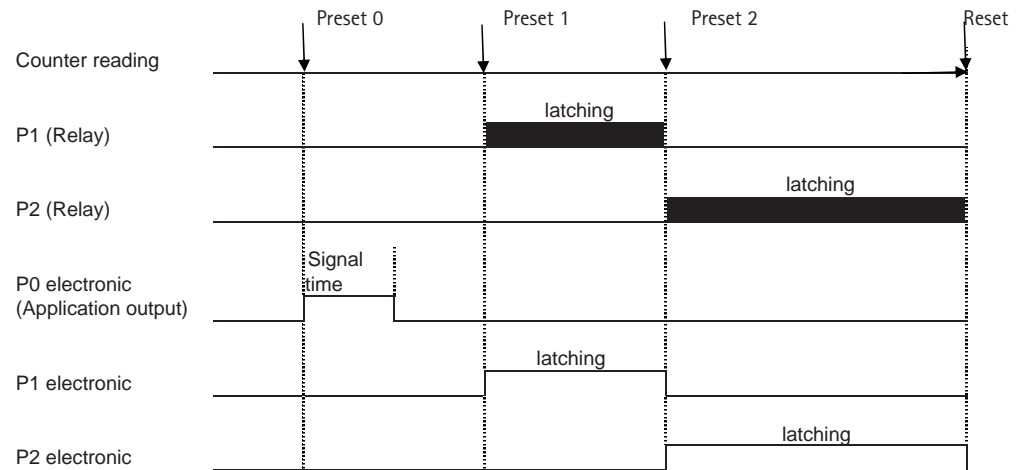

5 Pulse counter

Output signals latching
 Coincidence signal time P0 (F10) timed P1 (F11), P2 (F12) latching



5 Pulse counter

5.4 Programming the counter function codes

| | | | |
|---|---|---|--|
| <p>Enter Programming mode</p> <p>E + </p> <p>Keep pressed and simultaneously turn Power On</p> | <p>Change function setting</p> <p> or </p> <p>press</p> | <p>Save and change to next function</p> <p></p> <p>press</p> | <p>Return to display mode</p> <p>E</p> <p>press</p> |
| <p>Alternative display of function codes</p> | <p> + </p> | <p>The function codes are displayed as text in row 1. By pressing both keys simultaneously you can change to the numerical display (F 0 to F 35). After pressing these keys once again the number of the selectable options will be displayed in addition. This setting will be stored.</p> | |

5 Pulse counter

| Function code | Display Row 1 | Function | No. | Display Row 2 | |
|---------------|---------------|----------------------------|-----|---------------|---|
| F0 | F 0 0 0 0 0 | Factory Setting (Defaults) | 0* | 0 0 0 0 0 0 | No Function |
| | | | 1 | 0 0 0 0 0 0 | All Function Codes are set to the default values marked with * |
| F1 | C O U N T E R | Counter Mode | 0* | 0 0 0 0 0 0 | Input A Input B Input C Count. inpt. Gate/ Inhibit Reset |
| | | | 1 | 0 0 0 0 0 0 | Count.inpt. Direction. Input Reset |
| | | | 2 | 0 0 0 0 0 0 | Count.inpt. Direction. Input Gate/ Inhibit |
| | | | 3 | 0 0 0 0 0 0 | Adding Subtracting Reset |
| | | | 4 | 0 0 0 0 0 0 | Adding Subtracting Gate/ Inhibit |

5 Pulse counter

| | | | | | | | |
|----|---------|----------------------|----|---------|----------------------|-----------|---------------|
| | | | 5 | RRRR.RR | Adding | Adding | Reset |
| | | | 6 | RRRR.RR | Channel A | Channel B | Reset |
| | | | 7 | RRRR.RR | Channel A | Channel B | Gate/ Inhibit |
| F2 | RRRR.RR | Edge Evaluation | 0* | RRRR.RR | Single evaluation | | |
| | | /Quadrat. evaluation | 1 | RRRR.RR | Double evaluation | | |
| | | | 2 | RRRR.RR | Quadruple evaluation | | |
| F3 | RRRR.RR | PNP/NPN-Logic | 0 | RRRR.RR | NPN 8V-Level | | |
| | | | 1* | RRRR.RR | PNP 8-V Level | | |
| | | | 2 | RRRR.RR | NPN TTL-Level | | |

5 Pulse counter

| | | | | | | | |
|----|---------|-----------------------------|----|---------|---|--|--|
| | | | 3 | RRRR.RR | PNP TTL-Level | | |
| F4 | RRRR.RR | Input-damping (Attenuation) | 0 | RRRR.RR | 30 Hz damping (e.g. for mechanical contacts) | | |
| | | | 1* | RRRR.RR | F max. (see chapters 4 and 10) | | |
| F5 | RRRR.RR | Set / Re-set- Mode | 0* | RRRR.RR | Reset to 0 | | |
| | | | 1 | RRRR.RR | Automatic reset to 0 after reaching Preset 2 | | |
| | | | 2 | RRRR.RR | Set to Preset 2 | | |
| | | | 3 | RRRR.RR | Automatic selection of Preset 2 after reaching 0 | | |
| F6 | RRRR.RR | dynam./static Reset | 0* | RRRR.RR | Static reset (reset as long as the signal is applied) | | |

5 Pulse counter

| | | | | | |
|-----|--------|----------------|----|--------|---|
| | | | 1 | 84n888 | Dynamic Reset (ready to count after reset (even if reset signal is applied for a longer time) |
| F8 | 88E588 | Mode Preset 1 | 0* | 88E588 | P1 normal preset; absolute to the counter reading (coincidence signal) |
| | | | 1 | 88A888 | P1 as a trail preset with prefix (relative to P2) |
| | | | 2 | 88A885 | P1 as a trail preset symmetrical (relative to P2) |
| | | | 3 | 88A888 | P1 and P2 as a range signal (Signal 1 < P1, Signal 2 > P2) |
| F9 | 00E588 | Output signal | o* | 88E888 | Active On |
| | | | 1 | 88E8FF | Active Off |
| F10 | 580888 | Signal time PO | 0 | 885888 | Disabled / No output signal |
| | | | 1 | 885888 | Latching, reset with Preset 2 or Reset |

5 Pulse counter

| | | | | | |
|--|--|--|----|---------|---------|
| | | | 2 | 888002 | 0.02 s |
| | | | 3 | 888005 | 0.05 s |
| | | | 4* | 888010 | 0.10 s |
| | | | 5 | 888020 | 0.20 s |
| | | | 6 | 888050 | 0.50 s |
| | | | 7 | 888100 | 1.00 s |
| | | | 8 | 888200 | 2.00 s |
| | | | 9 | 888500 | 5.00 s |
| | | | 10 | 8881000 | 10.00 s |

5 Pulse counter

| | | | | |
|-----|--------|-----------------|--------|---|
| | | 11 | 050000 | User setting 1 (0-599,99 s) |
| | | 12 | 050002 | User setting (0-599,99 s) |
| | | 13 | 050003 | User setting 3 (0-599,99 s) |
| F11 | 500000 | Signal time P 1 | 0 | 050000 Disabled / No output signal |
| | | | 1 | 050000 Latching; with Preset 2 or Reset |
| | | | 2 | 000002 0.02 s |
| | | | 3 | 000005 0.05 s |
| | | | 4* | 000010 0.10 s |
| | | | 5 | 000020 0.20 s |

5 Pulse counter

| | | | | |
|-----|--------|----------------|--------|------------------------------------|
| | | 6 | 000050 | 0.50 s |
| | | 7 | 000100 | 1.00 s |
| | | 8 | 000200 | 2.00 s |
| | | 9 | 000500 | 5.00 s |
| | | 10 | 001000 | 10.00 s |
| | | 11 | 050000 | User setting 1 (0-599.99 s) |
| | | 12 | 050002 | User setting 2 (0-599.99 s) |
| | | 13 | 050003 | User setting 3 (0-599.99 s) |
| F12 | 500000 | Signal time P2 | 0 | 050000 Disabled / No Output signal |

5 Pulse counter

| | | |
|----|----------|---|
| 1 | 61.5E88 | Latching; Reset Cannot be used in conjunction with automatic Reset |
| 2 | 88.80.02 | 0.02 s |
| 3 | 88.80.05 | 0.05 s |
| 4* | 88.80.10 | 0.10 s |
| 5 | 88.80.20 | 0.20 s |
| 6 | 88.80.50 | 0.50 s |
| 7 | 88.81.00 | 1.00 s |
| 8 | 88.82.00 | 2.00 s |
| 9 | 88.85.00 | 5.00 s |

5 Pulse counter

| | | |
|-----|----------|-----------------------------|
| 10 | 88.80.00 | 10.00 s |
| 11 | 05E7.88 | User setting 1 (0-599.99 s) |
| 12 | 05E7.82 | User setting 2 (0-599.99 s) |
| 13 | 05E7.83 | User setting 3 (0-599.99 s) |
| F13 | 88.88.88 | Decimal point |
| 0* | 88.88.80 | No decimal point |
| 1 | 88.88.00 | 1 decimal place |
| 2 | 88.80.00 | 2 decimal places |
| 3 | 88.00.00 | 3 decimal places |
| 4 | 80.00.00 | 4 decimal places |

5 Pulse counter

| | | | | | |
|-----|----------|-----------------------------|----|---------|---|
| F14 | 888888 | Display flashes | 0* | 000000 | No flashing |
| | | | 1 | 8888P0 | Flashes as long as P0 is active |
| | | | 2 | 8888P1 | Flashes as long as P1 is active |
| | | | 3 | 8888P2 | Flashes as long as P2 is active |
| | | | 4 | P0P1P2 | Flashes as long as any preset is active |
| F15 | 2.888888 | 2 nd row display | 0 | 8888P0 | Preset 0 |
| | | | 1 | 8888P1 | Preset 1 |
| | | | 2* | 8888P2 | Preset 2 |
| | | | 3 | 8888P50 | Prescaler |

5 Pulse counter

| | | | | | |
|-----|--------|-------------------------------|----|--------|---|
| F16 | 000000 | Output at Reset (Interm. Cut) | 4 | 888888 | Totalizer |
| | | | 0* | 8888P2 | Do not activate Preset 2 during Reset |
| F17 | P0P1P2 | Power On (Reset) | 1 | 8888P2 | Activate Preset 2 during Reset |
| | | | 0* | 000000 | Restore counter value |
| F18 | 000000 | Output signal Memory | 1 | 8888P2 | Reset at Power On |
| | | | 0 | 8888P2 | Restart signal time after power failure  output switches |
| F19 | 888888 | Addtl. Totalizer | 1* | 8888P2 | Do not restart signal time after power failure |
| | | | 0 | 8888P2 | Enabled |
| | | | 1* | 8888P2 | Disabled |

5 Pulse counter

| F22 | 880000 | Applica. Input/ Output | 0 | P50000 | Prescaler output |
|-----|--------|------------------------------|----|--------|-----------------------------|
| | | | 1 | P00000 | Output Preset 0 |
| | | | 2 | d00000 | Directional output |
| | | | 3* | 0n0000 | Counter input - adding |
| | | | 4 | 0n000n | Counter input - subtracting |
| | | | 5 | 000000 | Reset input |
| | | | 6 | 0n0000 | Gate/Inhibit input |
| | | | 7 | 000000 | Keylock input |
| | | | 8 | H00000 | Hold input (display lock) |

5 Pulse counter

| | | |
|----|--------|--|
| 9 | 000000 | Teach input (count value becomes P2) |
| 10 | 500000 | Set input (Set to Preset 0) |
| 11 | 0n0000 | Latch and Reset (Save display at Reset) |



F24 - F27 are applicable to multifunction counters with a USB or Ethernet interface. Consult the supplement included with those versions.

| | | | | | |
|-----|--------|-------------------|----|--------|-------------------------------|
| F30 | 000000 | Lock Reset key | 0* | 000000 | Enable keyboard reset |
| | | | 1 | 000000 | Keyboard reset locked/delayed |
| F31 | P00000 | Lock Preset 0 | 0* | 000000 | P0 Setting enabled |
| | | | 1 | 000000 | P0 Setting locked / delayed |

5 Pulse counter

| | | | | | |
|-----|--------|------------------------|----|---------|-------------------------------|
| F32 | 888888 | Lock Preset 1 | 0* | 888888 | P1 Setting enabled |
| | | | 1 | 888888 | P1 Setting locked / delayed |
| F33 | 828888 | Lock Preset 2 | 0* | 888888 | P2 Setting enabled |
| | | | 1 | 888888 | P2 Setting locked / delayed |
| F34 | 850088 | Lock Prescaler setting | 0* | 888888 | PSC setting enabled |
| | | | 1 | 888888 | PSC Setting locked / delayed |
| F35 | 000000 | Lock Mode | 0* | 10.0000 | 10 seconds delay |
| | | | 1 | 888888 | Completely locked |
| | | | 2 | 100000 | Lock depends on keylock input |

6 Tachometer

6 Tachometer

6.1 Tachometer Description

(Supplementing the General Functions in Chapter 4)

| | |
|--------------------------------------|---|
| Operation: | A tachometer measures the period (PNP: time from one rising edge to the next one); NPN: time period from a falling edge to the next one), and converts and displays this time in 1/sec or 1/min. |
| Tachometer Mode of Operation: | The following modes of tachometer operation can be selected: Unidirectional counting; Unidirectional counting with directional input; Differential counting, summation (totalizing); Quadrature x1; x2 or x4; Indication of ratio A/B and Indication of percentage (A-B) /A in % |
| Decimal point | Tachometer mode of operation 0-4 (function code F1) The decimal point only serves for better legibility and does not change the value. Tachometer mode of operation 5 & 6 (function code F1) The decimal point is included in the calculation and increases the resolution. |

6 Tachometer

| | |
|--|---|
| Output signals Mode of operation: | The tachometer uses the following limit values: P 1 and P2 are limit (range) signals Output-Signal 1 is active at the displayed value of < P1 and Output-Signal 2 is active at the displayed value of > P2 Output-Signal 0 is active at the displayed value of > P0; (application output) |
| Display unit: | Programmable: 1/sec or 1/min Using the setting 1/min and prescaler 60 the display will show 1/hour. |
| Min. input frequency: | Programmable 1 Hz or 0.1 Hz. If two edges do not occur within 1 s or respectively, 10s, a value of 0 will be displayed. |
| Startup suppression: | Programmable Yes/No During the startup the lower limit signal is suppressed until the lower limit value is exceeded for the first time. The startup suppression will become active again, if the minimum frequency is fallen below. |





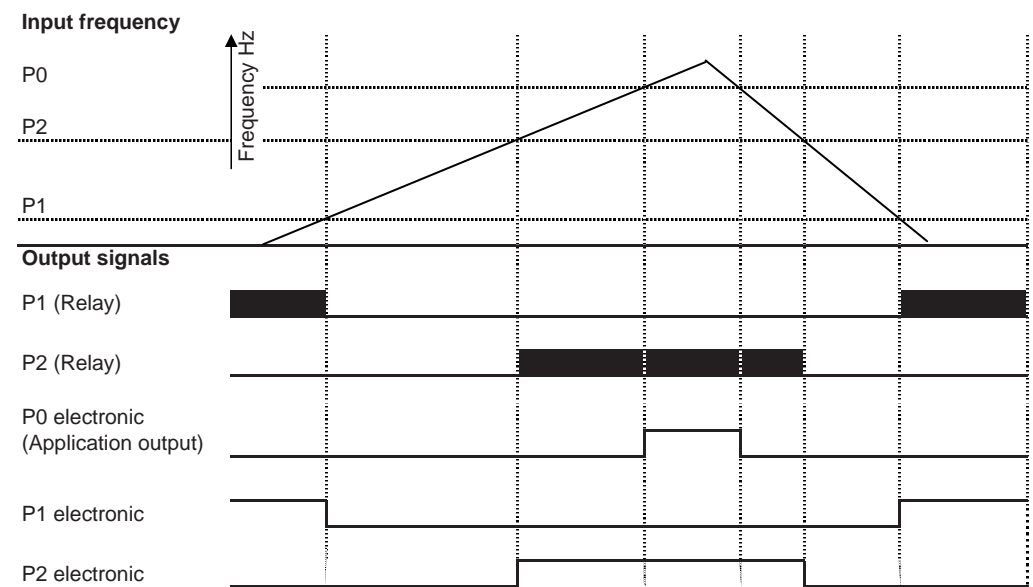

6 Tachometer

6.2 Signal diagram - Output signals



6 Tachometer

6.3 Programming the tachometer function codes

| | | | |
|---|---|---|--|
| <p>Enter Programming mode</p> <p>E + </p> <p>Keep pressed and simultaneously turn Power On</p> | <p>Change function setting</p> <p> or </p> <p>press</p> | <p>Save and change to next function</p> <p></p> <p>press</p> | <p>Return to display mode</p> <p>E</p> <p>press</p> |
| <p>Alternative display of Function code:</p> | <p> + </p> | <p>The function codes are displayed as text in row 1. By pressing both keys simultaneously you can change to the numerical display (F 0 to F 35). After pressing these keys once again the number of the selectable options will be displayed in addition. This setting will be stored.</p> | |

6 Tachometer

| Funktion code | Display Row 1 | Function | No. | Display Row 2 | | | | | | | | | | | | | | | |
|---------------|---------------|----------------------------|-----|---|---------|---------|---------|---------------|--------------|-----------------------|-------------|---------------|-----------------------|--------|-------------|-----------------------|--------|--------|-----------------------|
| F0 | F0E5EE | Factory Setting (Defaults) | 0* | 8888.08 No function | | | | | | | | | | | | | | | |
| | | | 1 | 888.4E5 All function codes are set to the values marked with * | | | | | | | | | | | | | | | |
| F1 | E0U8E8 | Tacho mode of operation | 0* | <table border="1"> <thead> <tr> <th>Input A</th> <th>Input B</th> <th>Input C</th> </tr> </thead> <tbody> <tr> <td>Counter input</td> <td>Gate/Inhibit</td> <td>Hold (Display memory)</td> </tr> <tr> <td>Count input</td> <td>Direct. input</td> <td>Hold (Display memory)</td> </tr> <tr> <td>Adding</td> <td>subtracting</td> <td>Hold (Display memory)</td> </tr> <tr> <td>Adding</td> <td>Adding</td> <td>Hold (Display memory)</td> </tr> </tbody> </table> | Input A | Input B | Input C | Counter input | Gate/Inhibit | Hold (Display memory) | Count input | Direct. input | Hold (Display memory) | Adding | subtracting | Hold (Display memory) | Adding | Adding | Hold (Display memory) |
| Input A | Input B | Input C | | | | | | | | | | | | | | | | | |
| Counter input | Gate/Inhibit | Hold (Display memory) | | | | | | | | | | | | | | | | | |
| Count input | Direct. input | Hold (Display memory) | | | | | | | | | | | | | | | | | |
| Adding | subtracting | Hold (Display memory) | | | | | | | | | | | | | | | | | |
| Adding | Adding | Hold (Display memory) | | | | | | | | | | | | | | | | | |
| | | | 1 | 888.8H8 | | | | | | | | | | | | | | | |
| | | | 2 | 885.8H8 | | | | | | | | | | | | | | | |
| | | | 3 | 888.8H8 | | | | | | | | | | | | | | | |

6 Tachometer

| | | | | | | | |
|----|--------|---|----|--------|--|-----------|-----------------------|
| | | | 4 | 900000 | Channel A | Channel B | Hold (Display memory) |
| | | | 5 | 000000 | Channel A / Channel B | | Hold (Display memory) |
| | | | 6 | 000000 | (A-B) / A in % (Difference in % of A) | | Hold (Display memory) |
| F2 | 900000 | Edge Evaluation/ Quadrat. evaluation | 0* | 000000 | Single evaluation | | |
| | | | 1 | 000000 | Dual evaluation | | |
| | | | 2 | 000000 | Quadruple evaluation | | |
| F3 | 000000 | PNP/ NPN- Logic | 0 | 000000 | NPN 8 V-Level | | |
| | | | 1* | 000000 | PNP 8 V-Level | | |

6 Tachometer

| | | | | | | | |
|----|--------|-----------------------------|----|--------|--|--|--|
| | | | 2 | 000000 | NPN TTL-Level | | |
| | | | 3 | 000000 | PNP TTL-Level | | |
| F4 | 000000 | Input damping (Attenuat) | 0 | 000000 | 30 Hz attenuation (e.g. for mechanical contacts) | | |
| | | | 1* | 000000 | F max. (see chapter 4 und 10) | | |
| F5 | 000000 | Display Unit | 0* | 000000 | Pulse per second (1/sec) | | |
| | | | 1 | 000000 | Pulse per minute (1/min) | | |
| F6 | 000000 | Min. Input frequency | 0* | 000000 | 1 Hz (if no further pulse is received after 1s, the display will return to 0) | | |
| | | | 1 | 000000 | 0,1 Hz (if no further pulse is received after 1s, the display will return to 0) | | |

6 Tachometer

| | | | | | |
|-----|--------|-----------------------|----|--------|------------------------------|
| F7 | 5E85UP | Startup-suppress. | 0 | 8884E5 | With startup suppression |
| | | | 1* | 88887a | Without startup suppression |
| F9 | 00E580 | Output signal | 0* | 8E880a | Active On |
| | | | 1 | 8E80FF | Active Off |
| F10 | 5808E0 | P0 Addtl. Upper limit | 0* | 885A6E | Disabled / no Output signal |
| | | | 1 | E8A6EE | Additional range signal > P0 |
| F11 | 5808E1 | P1 Lower limit | 0* | 885A6E | Disabled / no Output signal |
| | | | 1 | E8A6EE | Range signal < P1 |

6 Tachometer

| | | | | | |
|-----|--------|-----------------|----|---------|-----------------------------|
| F12 | 5808E2 | P2 Upper limit | 0* | 885A6E | Disabled / no Output signal |
| | | | 1 | E8A6EE | Range signal > P2 |
| F13 | 88888E | Decimal place | 0* | 888880 | No decimal point |
| | | | 1 | 8888.00 | 1 Decimal place |
| | | | 2 | 888.000 | 2 Decimal places |
| | | | 3 | 88.0000 | 3 Decimal places |
| | | | 4 | 8.00000 | 4 Decimal places |
| F14 | 8E8A5H | Display flashes | 0* | 88E85H | Do not flash |

6 Tachometer

| | | | | |
|-----|-------------|-----------------------------|------------|---------------------------------|
| | | 1 | 8.8.8.8 P0 | Flashes as long as P0 active |
| | | 2 | 8.8.8.8 P1 | Flashes as long as P1 active |
| | | 3 | 8.8.8.8 P2 | Flashes as long as P2 active |
| | | 4 | P0 P1 P2 | Flashes if any preset is active |
| F15 | 2.8.0.8.8 E | 2 nd row display | 0 | 8.8.8.8 P0 Preset 0 |
| | | | 1 | 8.8.8.8 P1 Preset 1 |
| | | | 2* | 8.8.8.8 P2 Preset 2 |
| | | | 3 | 8.8.8.8 P50 Prescaler |

6 Tachometer

| | | | | | |
|-----|-------------|--------------------------|----|-------------|---|
| F22 | 8.8.0.8.8 P | Application Input/Output | 0 | P0.8.8.8.8 | Output Preset 0 |
| | | | 1 | d.8.8.8.8.8 | Directional output |
| | | | 2* | 0.8.8.8.8.8 | Count input adding, or 2nd count input A |
| | | | 3 | 0.8.8.8.8.8 | Count input subtracting, or 2nd counter input B |
| | | | 4 | 0.8.8.8.8.8 | Gate/Inhibit Input |
| | | | 5 | H.8.8.8.8.8 | Hold-Input (display memory) |
| | | | 6 | E.E.8.8.8.8 | Teach Input (count value becomes P2) |
| | | | 7 | 0.8.8.8.8.8 | Keylock-Input |

6 Tachometer



F24 - F27 are applicable to multifunction counters with a USB or Ethernet interface. Consult supplement included with those versions.

| | | | | | |
|-----|--------|------------------------|----|--------|-----------------------------|
| F31 | P00000 | Lock Pre-set 0 Setting | 0* | 000000 | P0 Setting enabled |
| | | | 1 | 888000 | P0 Setting locked / delayed |
| F32 | P10000 | Lock Pre-set 1 Setting | 0* | 000000 | P1 Setting enabled |
| | | | 1 | 888000 | P1 Setting locked / delayed |
| F33 | P20000 | Lock Pre-set 2 Setting | 0* | 000000 | P2 Setting enabled |
| | | | 1 | 888000 | P2 Setting locked / delayed |

6 Tachometer

| | | | | | |
|-----|--------|------------------------|----|--------|------------------------------------|
| F34 | P50000 | Lock Prescaler Setting | 0* | 000000 | PSC Setting enabled |
| | | | 1 | 888000 | PSC Setting locked / delayed |
| F35 | 000000 | Lock Mode | 0* | 100500 | 10 seconds delay |
| | | | 1 | 800000 | Completely locked |
| | | | 2 | 100000 | Lock mode depends on Keylock Input |

7 Timer

7 Timer

7.1 Timer Description

(Supplementing the General Functions in Chapter 4)

| | |
|----------------------|---|
| Function: | The timer counts seconds, minutes or hours. Depending on the resolution (see below) the smallest units to be recorded are 0.1 ms. Combined with the prescaler (see below), quantities can be measured as a function of time. |
| Time formats: | 4 time formats are available: Seconds, minutes, hours and HH:MM:SS |
| Resolution: | By shifting the decimal place, a resolution of up to 4 decimal places can be programmed; the smallest resolution is 0.1 ms. The time format "seconds with four decimal places" shows 0.1 milliseconds. The time format "seconds with three decimal places" shows milliseconds. The time format "minutes with two decimal places" shows 1/100 minutes. |

7 Timer

| | |
|--|--|
| Prescaler: | During the timer operation the prescaler has to be disabled or set to 01.0000. The prescaler can be used to record quantities, provided that the quantity per time unit is known and constant. Example: A volume of 3 liters per second is supplied. Settings: Time format "seconds", prescaler 3.0000 Display: Supplied volume in liters as a function of time. The prescaler cannot be used with the time format HH:MM:SS as it is not applicable in this application. |
| Timer mode of operation: | The following modes of timer operation can be selected: Cumulative measurement following the pulse-width measuring principle (Cumulative measurement as long as input A is active) Cumulative measurement following the cycle-duration principle (Cumulative measurement from rising edge Input A to falling edge of Input A) Cumulative measurement A=Run, B=Stop (cumulative measurement from rising edge Input A to rising edge Input B) Single-pulse measurement following the pulse-width measurement principle (Measure as long as Input A is active) Single-pulse measurement following the cycle-duration principle (Measurement from rising edge Input A to rising edge of Input A) Single-pulse measurement A=Run, B=Stop (Cumulative measurement from rising edge Input A to rising edge Input B) |
| Manual Start / Stop via keyboard: | The Start / Stop function can be set via the keyboard. Start: Press the UP button for 0.5s Stop: Press the DOWN button. |

| | |
|--|---|
| <p>Output signals – Function:</p> | <p>A) coincidence signal: The timer operates in the “coincidence” mode, i.e. the output signals are enabled for the programmed period of time after reaching the selected preset value B) trail signal: P2 and P0 operate in the “coincidence” mode, i.e. the output signals are enabled for the programmed period of time when reaching the selected preset value. P1 is a trail preset and not absolute to 0, but relative to P2. If the setting is F8=1, the following will apply: Signal 1 is returned at P2 – P1 Example: P2=1000, P1=200, Signal 1 at 800; If P1 is negative: P2=1000, P1=(-200), Signal 1 at 1200 If the setting is F8=2, the following will be applicable: Signal 1 is returned at P2 + und – P1 (Example: P2=1000, P1=200, Signal 1 at 800 or/and 1200) C) range signal: P1 and 2 are range signals: Output-Signal 1 is active at timer reading < P1 and Output-Signal 2 is active at timer reading > P2 D) batch mode: The timer can also be programmed to act as a batch counter. In this case, P2= main preset value; P1= Batch preset. In the Batch mode of operation, only positive entries are possible for P1; negative entries will be stored as positive values. This mode is ideal to default a process time and the number of process sequences (runs).</p> |
| <p>Additional totalizer</p> | <p>The additional totalizer is used to sum up all the times (even after repeated resetting of the main counter). The totalizer is reset separately.</p> |

7.2 Signal Diagrams – Input signals

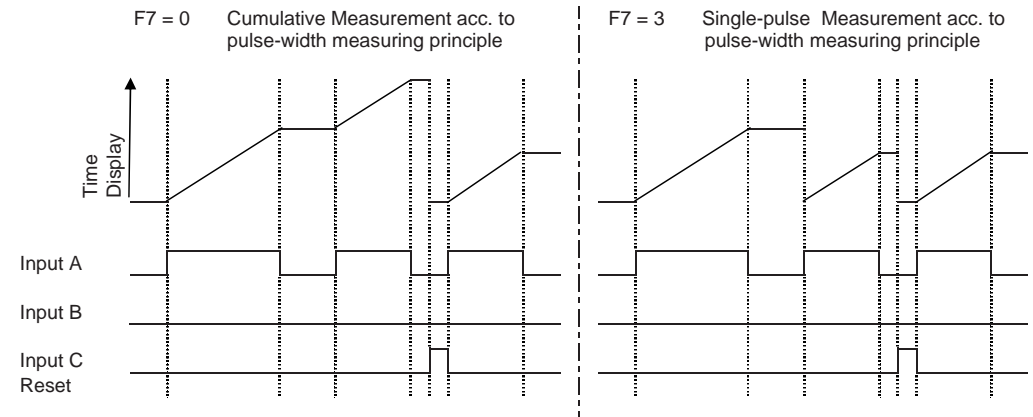

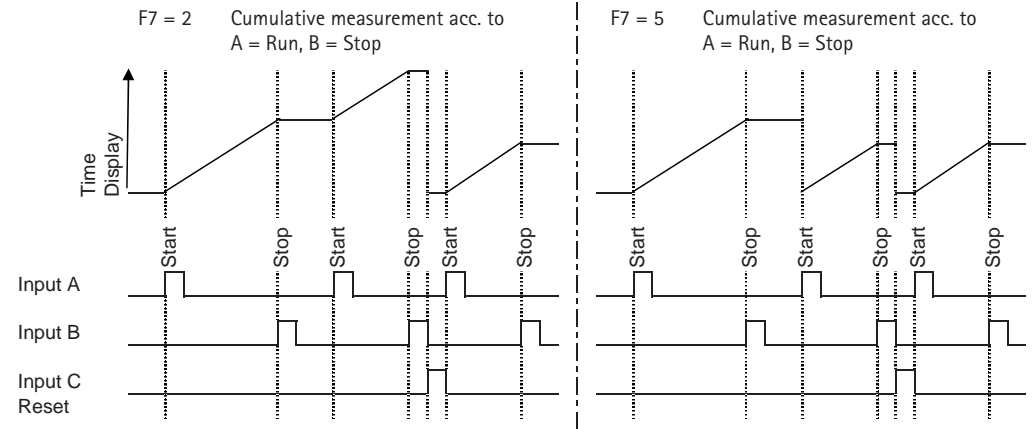
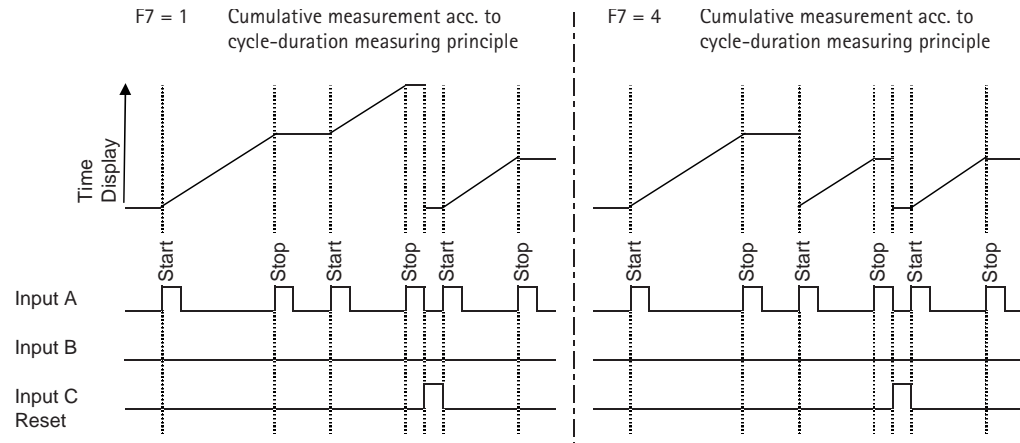







7 Timer

7.3 Signal Diagrams – Output signals

The output signals of the timer can be derived from the pulse counter (see 5.3) or, respectively, batch counter (see 9.2) functions.

7.4 Programming the Timer Function Codes

| | | | |
|---|--|--|---|
| Enter Programming mode | Change function setting | Save and change to next function | Return to display mode |
|  |  oder  |  |  |
| Keep pressed and simultaneously turn Power On | press | press | press |
| Alternative display of function codes |  +  | The function codes are displayed as text in row 1. By pressing both keys simultaneously you can change to the numerical display (F 0 to F 35). After pressing these keys once again the number of the selectable options will be displayed in addition. This setting will be stored. | |

7 Timer

| Function code | Display Row 1 | Function No. | Display Row 2 |
|---------------|---------------|----------------------------|---|
| F0 | F0E5EE | Factory Setting (Defaults) | 0* 8888.00 No function |
| | | 1 | 888YES All function codes are set to the values marked with * |
| F1 | 0.00E88 | Time unit | 0* 5E20.00 Seconds |
| | | 1 | 0.00000 Minutes |
| | | 2 | 8.00005 Hours |
| | | 3 | HH.MM.SS HH:MM:SS |
| F2 | F250.00 | Resolution | 0* 8888.00 No decimal point |

7 Timer

| | | | | | |
|----|-----------|-------------------|----|------------|------------------|
| | | | 1 | 8.8.8.8.0 | 1 decimal place |
| | | | 2 | 8.8.8.0.00 | 2 decimal places |
| | | | 3 | 8.8.0.000 | 3 decimal places |
| | | | 4 | 8.0.0.000 | 4 decimal places |
| F3 | 8.8.8.8.8 | PNP/NPN- Logic | 0 | 0.0.0.0.0 | NPN 8 V-Level |
| | | | 1* | 0.0.0.0.0 | PNP 8 V-Level |
| | | | 2 | 0.0.0.0.0 | NPN TTL-Level |
| | | | 3 | 0.0.0.0.0 | PNP TTL-Level |

7 Timer

| | | | | | |
|----|-----------|---------------------------|----|-----------|---|
| F4 | 8.8.8.8.8 | Input (Attenuat) | 0 | 0.0.0.0.0 | 30 Hz damping (attenuation) (e.g. for mechanical contacts) |
| | | | 1* | 0.0.0.0.0 | F max. (see chapter 4 and 10) |
| F5 | 8.8.8.8.8 | Set / Re- set- Mode | 0* | 0.0.0.0.0 | Reset to 0 |
| | | | 1 | 0.0.0.0.0 | Automatic reset to 0 after reaching Preset 2 |
| | | | 2 | 0.0.0.0.0 | Set to Preset 2 |
| | | | 3 | 0.0.0.0.0 | Automatically sets to Preset 2 after reaching 0. |
| F6 | 8.8.8.8.8 | dynam/ static Reset | 0* | 0.0.0.0.0 | Static Reset (as long as the signal is applied) |
| | | | 1 | 0.0.0.0.0 | Dynamic Reset (ready for operation, even if reset signal has been applied for a longer time) |

7 Timer

| | | | | | |
|----|--------|--------------------------------|----|---------|--|
| F7 | E88E88 | Timer- Mode of Operation | 0 | E088P00 | Cumulative measurement – pulse-width (counts as long as Input A is active) |
| | | | 1* | E088PEE | Cumulative measurement – cycle duration (counts from rising edge of start signal to rising edge of stop signal). |
| | | | 2 | E088F85 | Cumulative measurement – A=Run B=Stop (counts from rising edge of start signal to rising edge of stop signal). |
| | | | 3 | 5888P00 | Single-pulse measurement – pulse-width (counts as long as Input A is active) |
| | | | 4 | 5888PEE | Single-pulse measurement – cycle duration (counts from rising edge of start signal to rising edge of stop signal). |
| | | | 5 | 5888F85 | Single-pulse measurement – A=Run B=Stop (counts from rising edge of start signal to rising edge of stop signal) |
| F8 | 88E588 | Mode Preset 1 | 0* | 88E588 | P1 normal preset; absolute to counter reading (coincidence signal) |

7 Timer

| | | | | | |
|-----|--------|--------------------|----|--------|--|
| | | | 1 | E88800 | P1 is a trail preset with prefix (relative to P2) |
| | | | 2 | E88805 | P1 is a symmetric trail (relative to P2) |
| | | | 3 | 888800 | P1 and P2 are range signals (Signal 1 < P1, Signal 2 > P2) |
| F9 | 00E580 | Output signal | 0* | 88E808 | Active On |
| | | | 1 | 88E0FF | Active Off |
| F10 | 580800 | Signal time P 0 | 0 | 885860 | Disabled / No output signal |
| | | | 1 | 885886 | Latching, reset with Preset 2 or Reset |
| | | | 2 | 888002 | 0.02 s |

7 Timer

| | | |
|----|------------|---------|
| 3 | 8.8.8.0.05 | 0.05 s |
| 4* | 8.8.8.0.10 | 0.10 s |
| 5 | 8.8.8.0.20 | 0.20 s |
| 6 | 8.8.8.0.50 | 0.50 s |
| 7 | 8.8.8.1.00 | 1.00 s |
| 8 | 8.8.8.2.00 | 2.00 s |
| 9 | 8.8.8.5.00 | 5.00 s |
| 10 | 8.8.8.0.00 | 10.00 s |

7 Timer

| | | | | | |
|-----|--------|----------------|----|------------|--|
| | | | 11 | 05E0.00 | User setting 1 (0-599.99 s) |
| | | | 12 | 05E0.02 | User setting 2 (0-599.99 s) |
| | | | 13 | 05E0.03 | User setting 3 (0-599.99 s) |
| F11 | 500000 | Signal time P1 | 0 | 05A0.00 | Disabled / no output signal |
| | | | 1 | 05E0.06 | Latching, reset with Preset 2 or Reset |
| | | | 2 | 8.8.8.0.02 | 0.02 s |
| | | | 3 | 8.8.8.0.05 | 0.05 s |
| | | | 4* | 8.8.8.0.10 | 0.10 s |

7 Timer

| | | |
|----|---------|-----------------------------|
| 5 | 8880.20 | 0.20 s |
| 6 | 8880.50 | 0.50 s |
| 7 | 8881.00 | 1.00 s |
| 8 | 8882.00 | 2.00 s |
| 9 | 8885.00 | 5.00 s |
| 10 | 8810.00 | 10.00 s |
| 11 | 0560.00 | User setting 1 (0-599.99 s) |
| 12 | 0560.02 | User setting 2 (0-599.99 s) |

7 Timer

| | | | | | |
|-----|--------|----------------|----|---------|--|
| | | | 13 | 0560.03 | User setting 3 (0-599.99 s) |
| F12 | 510000 | Signal time P2 | 0 | 0560.00 | Disabled / No output signal |
| | | | 1 | 0560.00 | Latching; Reset function cannot be used in connection with automatic Reset |
| | | | 2 | 8880.02 | 0.02 s |
| | | | 3 | 8880.05 | 0.05 s |
| | | | 4* | 8880.10 | 0.10 s |
| | | | 5 | 8880.20 | 0.20 s |
| | | | 6 | 8880.50 | 0.50 s |

7 Timer

| | | |
|----|------------|-----------------------------|
| 7 | 8.8.8.1.00 | 1.00 s |
| 8 | 8.8.8.2.00 | 2.00 s |
| 9 | 8.8.8.5.00 | 5.00 s |
| 10 | 8.8.10.00 | 10.00 s |
| 11 | 0.5.0.0.01 | User setting 1 (0-599.99 s) |
| 12 | 0.5.0.0.02 | User setting 2 (0-599.99 s) |
| 13 | 0.5.0.0.03 | User setting 3 (0-599.99 s) |

7 Timer

| | | | | | |
|-----|-------------|-------------------------------------|----|-------------|--|
| F13 | P.8.5.0.0.P | Stop after reaching the main Preset | 0* | 8.8.8.0.0 | No Stop when main Preset is reached (P2) |
| | | | 1 | 8.8.8.4.0.5 | Stop when main Preset is reached (P2) |
| F14 | 8.8.0.5.H | Display flashes | 0* | 0.0.0.5.H | Do not flash |
| | | | 1 | 8.8.8.0.P.0 | Flashes as long as P0 is activ |
| | | | 2 | 8.8.8.0.P.1 | Flashes as long as P1 is active |
| | | | 3 | 8.8.8.0.P.2 | Flashes as long as P2 is active |
| | | | 4 | P.0.0.0.0.2 | Flashes as long as any preset is active |
| F15 | 2.8.0.0.0.E | 2 nd row display | 0 | 8.8.8.0.P.0 | Preset 0 |

7 Timer

| | | | | | |
|-----|--------|------------------------------------|----|--------|--|
| | | | 1 | 8888P1 | Preset 1 |
| | | | 2* | 8888P2 | Preset 2 |
| | | | 3 | 888P50 | Prescaler |
| | | | 4 | 000000 | Totalizer / Batchcounter |
| F16 | 0000SE | Start / Stop via Keyboard (manual) | 0* | 005000 | Start / Stop locked via keys UP key=Start; DOWN key = Stop |
| | | | 1 | 000000 | Start / Stop enabled via keys UP key =Start; DOWN key =Stop |
| F17 | 0000ES | Power-On Reset | 0* | 0000ES | Restore counter value |
| | | | 1 | 8880ES | Reset at Power On |

7 Timer

| | | | | |
|-----|--------|----------------------|--------|---|
| F18 | 000000 | Output Signal Memory | 888YES | Restart signal time after power fail  output switches |
| | | | 888000 | Do not restart signal time after power fail |
| F19 | 000000 | Addtl. Totalizer | 888YES | Enabled |
| | | | 888000 | Disabled |
| F20 | 000000 | Prescaler | 005000 | Prescaler not active |
| | | | 000000 | Prescaler active |
| F21 | 000000 | Timer Type | 000000 | Preset timer |
| | | | 000000 | Batch timer |

7 Timer

| | | | | | |
|-----|---------|----------------------------|----|--------|--|
| F22 | PPU000P | Appli- cation Output | 0 | PO0000 | Output Preset 0 |
| | | | 1* | PR0000 | Run-Input |
| | | | 2 | SE0P00 | Stop-Input |
| | | | 3 | RESR00 | Reset counter and totalizer or batch counter |
| | | | 4 | RES000 | Reset - only counter |
| | | | 5 | RES000 | Reset - only totalizer or batch counter |
| | | | 6 | 000000 | Keylock input |
| | | | 7 | HO0000 | Hold input (display memory) |

7 Timer

| | | |
|---|--------|--------------------------------------|
| 8 | EE0000 | Teach Input (count value becomes P2) |
| 9 | SE0000 | Set Input (set to Preset 0) |



F24 - F27 are applicable to multifunction counters with a USB or Ethernet interface. Consult the supplement included with those versions.

| | | | | | |
|-----|--------|---------------------------------|----|--------|---------------------------------|
| F30 | RES000 | Lock Reset Key | 0* | 000000 | Keyboard reset enabled |
| | | | 1 | 000000 | Keyboard reset locked / delayed |
| F31 | PO0000 | Lock Pre- set 0 Set- ting | 0* | 000000 | P0 Setting enabled |
| | | | 1 | 000000 | P0 Setting locked / delayed |

7 Timer

| | | | | | |
|-----|--|------------------------|----|--|--|
| F32 | | Lock Pre-set 1 Setting | 0* | | P1 Setting enabled |
| | | | 1 | | P1 Setting locked / delayed |
| F33 | | Lock Pre-set 2 Setting | 0* | | P2 Setting enabled |
| | | | 1 | | P2 Setting locked / delayed |
| F34 | | Lock Prescaler Setting | 0* | | PSC Setting enabled |
| | | | 1 | | PSC Setting locked / delayed |
| F35 | | Lock Mode | 0* | | 10 seconds delay |
| | | | 1 | | Completely locked |
| | | | 2 | | Lock function depending on Keylock input |

8 Shift Counter

8 Shift Counter

8.1 Shift Counter Description

(Supplementing the general description under 4)

| | |
|--|---|
| Function: | 2-shift counters enable the acquisition of 2 separate partial sums. Counter input A acts on partial sum 1, whereas counter input B acts on partial sum 2. Both partial sums are counted positively; the total sum is calculated mathematically and corresponds to the summed-up total (or respectively, the difference) of the partial sums. The total sum remains unchanged after resetting one of the partial sums. |
| Counter mode of operation: | The following counter modes of operation can be selected: Difference counting and summation (totalizing) |
| Output signals – mode of operation: | The counter operates in the "coincidence" mode, i.e. the output signals are enabled for the programmed period of time after reaching the selected Preset value. The total sum acts on Preset 0 Partial sum 1 acts on Preset 1 Partial sum 2 acts on Preset 2 |

8 Shift Counter

| | |
|------------------|--|
| Reset | <p>After a reset at input C, both partial sums and the total sum are reset.</p> <p>When resetting via the application input it is possible to reset one or both of the partial sums or the total sum, depending on the selected programming.</p> <p>When resetting via the keyboard, only the value shown on the display is reset.</p> |
| Totalizer | The totalizer sums up all the input pulses, even if the partial sums and the total sum are reset. The totalizer can only be reset manually. |

8.2 Scrolling between Total Sum and Partial Sums

The Shift key is used to scroll between the total sum and partial sums 1 and 2. If a partial sum is shown, SU1 or SU2 will flash in the lower display bar.

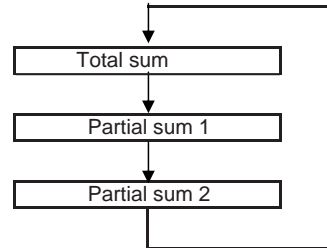

8 Shift Counter

8.3 Signal diagrams – Inputs (PNP Logic)

Adding/Adding (F1= A A r)

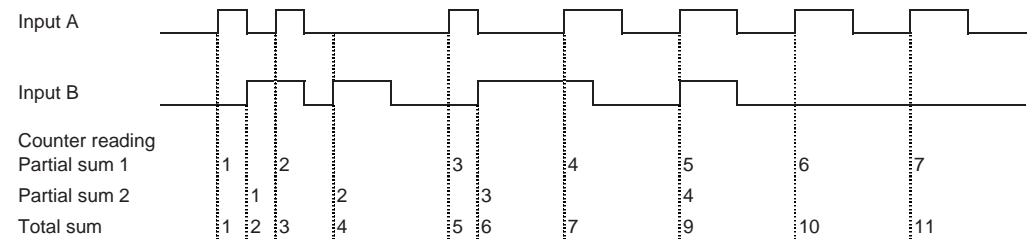

8 Shift Counter

Adding/Subtracting (F1= A S r)

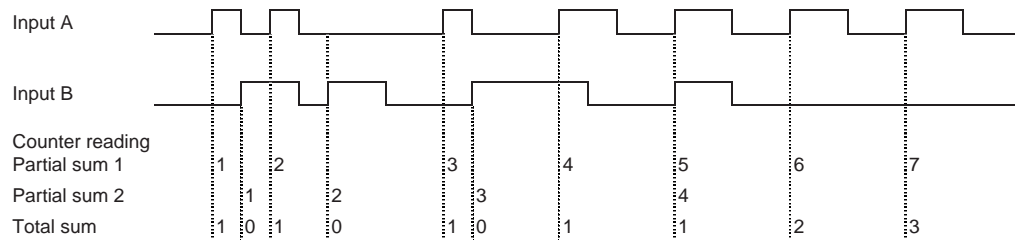

8 Shift Counter

8.4 Signal Diagrams - Output signals

Output signals - timed

Coincidence signals P 0/Total Sum (F10), P 1/Partial sum 1 (F11), P 2/Partial sum 2 (F12) timed

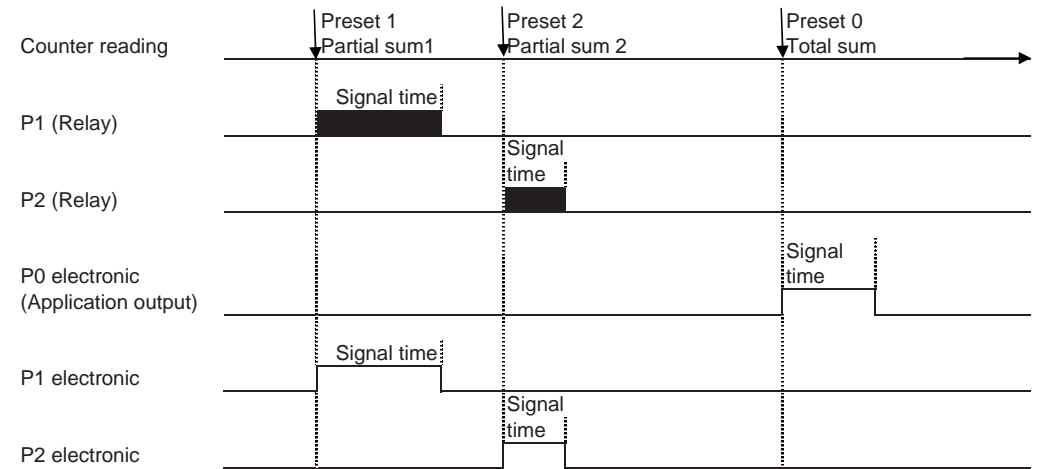

8 Shift Counter

8.5 Programming the Shift Counter Function Codes

| | | | |
|--|-------------------------|--|------------------------|
| Enter Programming mode | Change function setting | Save and change to next function | Return to display mode |
| | | | |
| Keep pressed and simultaneously turn Power On | press | press | press |
| Alternative display of Function codes | | The function codes are displayed as text in row 1. By pressing both keys simultaneously you can change to the numerical display (F 0 to F 35). After pressing these keys once again the number of the selectable options will be displayed in addition. This setting will be stored. | |

8 Shift Counter

| Function code | Display Row 1 | Function No. | Display Row 2 |
|---------------|---------------|--|-------------------------|
| F0 | F0E5EE | Factory Setting (Defaults) | 0* 888.888 No function |
| | | 1 888.9E5 All function codes are set to the values marked with * | |
| F1 | COUNT | Counter mode of Operation | Input A Input B Input C |
| | | 0 885.888 Adding Subtracting Reset | |
| | | 1* 888.888 Adding Adding Reset | |
| F3 | PNP/NPN-Logic | 0 888.888 NPN 8 V-Level | |

8 Shift Counter

| | | | | |
|----|-----------------------|----|---|---------------|
| | | | 1* | PNP 8 V-Level |
| | | | 2 | NPN TTL-Level |
| | | | 3 | PNP TTL-Level |
| F4 | Input Attenuat. | 0 | 30 Hz damping (attenuation); e.g. for mechanical contacts | |
| | | 1* | F max. (see chapter 4 and 10) | |
| F5 | With / without Preset | 0 | With Preset | |
| | | 1* | Without Preset | |

8 Shift Counter

| | | | |
|-----|---|----|---|
| F6 | Dynamic/ static Reset | 0* | Static Reset (reset as long as signal is applied) |
| | | 1 | Dynamic Reset (ready for counting, even if reset signal has been applied for a longer time) |
| F9 | Output signal | 0* | Active On |
| | | 1 | Active Off |
| F10 | Signal time P ₀ Total Sum | 0 | Disabled / no output signal |
| | | 1 | Latching; reset with Reset |
| | | 2 | 0.02 s |
| | | 3 | 0.05 s |

8 Shift Counter

| | | |
|----|-------------|-----------------------------|
| 4* | 8.8.8.0.10 | 0.10 s |
| 5 | 8.8.8.0.20 | 0.20 s |
| 6 | 8.8.8.0.50 | 0.50 s |
| 7 | 8.8.8.1.00 | 1.00 s |
| 8 | 8.8.8.2.00 | 2.00 s |
| 9 | 8.8.8.5.00 | 5.00 s |
| 10 | 8.8.10.00 | 10.00 s |
| 11 | 0.5.0.0.0.0 | User setting 1 (0-599.99 s) |

8 Shift Counter

| | | | | | |
|-----|-------------|------------------------------|----|-------------|-----------------------------|
| | | | 12 | 0.5.0.0.0.2 | User setting 2 (0-599.99 s) |
| | | | 13 | 0.5.0.0.0.3 | User setting 3 (0-599.99 s) |
| F11 | 5.8.0.8.8.8 | Signal time P1 Partial sum 1 | 0 | 8.8.5.8.8.0 | Disabled / no output signal |
| | | | 1 | 8.8.5.8.8.6 | Latching; reset with Reset |
| | | | 2 | 8.8.8.0.0.2 | 0.02 s |
| | | | 3 | 8.8.8.0.0.5 | 0.05 s |
| | | | 4* | 8.8.8.0.1.0 | 0.10 s |
| | | | 5 | 8.8.8.0.2.0 | 0.20 s |

8 Shift Counter

6 8880.50 0.50 s

7 8881.00 1.00 s

8 8882.00 2.00 s

9 8885.00 5.00 s

10 8810.00 10.00 s

11 0560.88 User setting 1 (0-599.99 s)

12 0560.82 User setting 2 (0-599.99 s)

13 0560.83 User setting 3 (0-599.99 s)

8 Shift Counter

F12 580822 Signal time P2 Partial sum 2 0 885860 Disabled / no output signal

1 615886 Latching; reset with Reset

2 8880.02 0.02 s

3 8880.05 0.05 s

4* 8880.10 0.10 s

5 8880.20 0.20 s

6 8880.50 0.50 s

7 8881.00 1.00 s

8 Shift Counter

| | | |
|----|-------------|---------------------------------|
| 8 | 8.8.8.2.00 | 2.00 s |
| 9 | 8.8.8.5.00 | 5.00 s |
| 10 | 8.8.8.0.00 | 10.00 s |
| 11 | 0.5.0.0.8.0 | User-Einstellung 1 (0-599.99 s) |
| 12 | 0.5.0.0.8.2 | User-Einstellung 2 (0-599.99 s) |
| 13 | 0.5.0.0.8.3 | User-Einstellung 3 (0-599.99 s) |

| | | | | | |
|-----|-------------|---------------|----|-------------|------------------|
| F13 | 8.8.8.8.8.8 | Decimal Point | 0* | 8.8.8.8.8.0 | No decimal point |
| | | | 1 | 8.8.8.8.0.0 | 1 decimal place |

8 Shift Counter

| | | |
|---|------------|------------------|
| 2 | 8.8.8.0.00 | 2 decimal places |
| 3 | 8.8.0.0.00 | 3 decimal places |
| 4 | 8.0.0.0.00 | 4 decimal places |

| | | | | | |
|-----|-------------|-----------------|----|-------------|---------------------------------|
| F14 | 8.8.8.8.8.8 | Display flashes | 0* | 0.8.8.8.8.8 | Do not flash |
| | | | 1 | 8.8.8.8.P.0 | Flashes as long as P0 is active |
| | | | 2 | 8.8.8.8.P.1 | Flashes as long as P1 is active |
| | | | 3 | 8.8.8.8.P.2 | Flashes as long as P2 is active |
| | | | 4 | P.0.8.8.8.8 | Flashes if any Preset is active |

8 Shift Counter

| | | | | | |
|-----|-------------|-----------------------------|----|-------------|---------------|
| F15 | 2.8.0.0.0.E | 2 nd row display | 0 | 8.8.8.8.P.0 | Preset 0 |
| | | | 1 | 8.8.8.8.P.1 | Preset 1 |
| | | | 2* | 8.8.8.8.P.2 | Preset 2 |
| | | | 3 | 8.8.8.P.5.0 | Prescaler |
| | | | 4 | 8.8.8.5.0.1 | Partial sum 1 |
| | | | 5 | 8.8.8.5.0.2 | Partial sum 2 |
| | | | 6 | 8.8.8.E.0.E | Totalizer |

8 Shift Counter

| | | | | | |
|-----|-------------|---------------------------|----|-------------|--|
| F17 | P.0.N.F.E.S | Power-On Reset | 0* | 0.8.8.8.E.S | Restores the counter value |
| | | | 1 | 8.8.8.8.E.S | Reset at Power On |
| F18 | 0.V.E.N.E.N | Output Signal Memory | 0 | 8.8.8.4.E.S | Restart signal time after power fail  output switches |
| | | | 1* | 8.8.8.8.0.0 | Do not restart signal time after power fail |
| F19 | 8.8.8.E.0.E | Addtl. Totalizer | 0 | 8.8.8.4.E.S | Additional totalizer is enabled |
| | | | 1* | 8.8.8.8.0.0 | No additional totalizer |
| F22 | 8.P.0.0.N.P | Appli-cation Input/Output | 0 | P.0.8.0.0.E | Output Preset value 0 |
| | | | 1* | 8.2.8.8.0.P | 2nd counter input partial sum 1 |

8 Shift Counter

| | | |
|---|--------|---------------------------------|
| 2 | 628888 | 2nd counter input partial sum 2 |
| 3 | 6E5851 | Reset of partial sum 1 |
| 4 | 6E5852 | Reset of partial sum 2 |
| 5 | 6E5582 | Reset of both partial sums |
| 6 | 6E5E8E | Reset of total sum |
| 7 | H88888 | Hold Input (display memory) |
| 9 | 888888 | Keylock Input |



F24 - F27 are applicable to multifunction counters with a USB or Ethernet interface. Consult the supplement included with those versions.

8 Shift Counter

| | | | | | |
|-----|--------|-------------------|----|--------|---------------------------------|
| F30 | 6E508E | Lock Reset key | 0* | 888888 | Keyboard reset enabled |
| | | | 1 | 888888 | Keyboard reset locked / delayed |
| F31 | P0888E | Lock Preset 0 | 0* | 888888 | P0 Setting enabled |
| | | | 1 | 888888 | P0 Setting locked / delayed |
| F32 | P1888E | Lock Preset 1 | 0* | 888888 | P1 Setting enabled |
| | | | 1 | 888888 | P1 Setting locked / delayed |
| F33 | P2888E | Lock Preset 2 | 0* | 888888 | P2 Setting enabled |
| | | | 1 | 888888 | P2 Setting locked / delayed |

8 Shift Counter

| | | | | | |
|-----|--------|------------------------------|----|--------|------------------------------------|
| F34 | 850000 | Lock Prescaler Setting | 0* | 000000 | PSC Setting enabled |
| | | | 1 | 000000 | PSC Setting locked / delayed |
| F35 | 000000 | Lock Mode | 0* | 100500 | 10 seconds delay |
| | | | 1 | 000000 | Completely locked |
| | | | 2 | 100000 | Lock mode depends on keylock input |

9 Batch Counter

9 Batch Counter

9.1 Batch Counter Description

(Supplementing the general description in Chapter 4)

| | |
|--|--|
| Function: | <p>Preset 2 is the main Preset setting. Preset 1 is the Batch Preset or, respectively, the preset value of the 2nd totalizer.</p> <p>In the batch operation the batch counter counts how often the main Preset is activated. Example of an application: during length cutting operations, for example, both the lengths (main preset) and number (batch preset) can be monitored. In the Batch mode of operation, only positive entries are possible for P1; negative entries will be stored as positive values.</p> |
| Counter mode of operation: | <p>The following modes of operation can be adjusted for the counter: Unidirectional counting, adding or subtracting; Unidirectional counting with directional input; Difference counting, summation and Quadrature x1; x2 or x4.</p> |
| Output signals Mode of Operation: | <p>The counter operates in the coincidence mode, i.e. the output signals are enabled for the programmed duration when the selected preset value is reached.</p> |

9 Batch Counter

Prescaler Output PSC-out:

The Prescaler output is an application output.

With each increase of the counter reading the number of output pulses corresponds to the respective number of increments.

The pulse length of the prescaler output corresponds to a frequency of 500 Hz.

When using the prescaler output the max. input frequency is:

$$F_{max} = 500 / PSC.$$

So it is possible that the maximum input frequency can not be reached.

9 Batch Counter





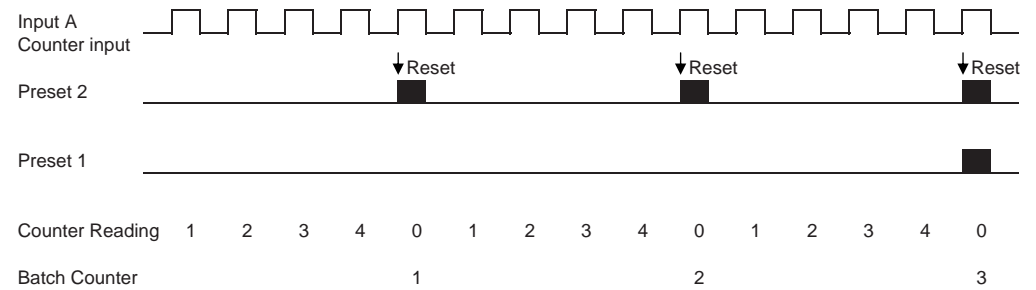



9.2 Signal Diagrams - Inputs and Outputs

Unidirectional count (F1 = C G r), Batch counter (F19 = batch),
Preset 2 (Main Preset = 5, Preset 1 (Batch Preset) = 3



9 Batch Counter

9.3 Programming the Batch Counter Function Codes

| | | | |
|---|--|--|---|
| Enter Programming mode | Change function setting | Save and change to next function | Return to display mode |
|  +  |  or  |  |  |
| Keep pressed and simultaneously turn Power On | press | press | press |
| Alternative display of Function codes |  +  | The function codes are displayed as text in row 1. By pressing both keys simultaneously you can change to the numerical display (F 0 to F 35). After pressing these keys once again the number of the selectable options will be displayed in addition. This setting will be stored. | |

9 Batch Counter

| Function code | Display Row 1 | Function | No. | Display Row 2 | |
|---------------|---------------|----------------------------|-----|---------------|---|
| F0 | F0E5EE | Factory Setting (Defaults) | 0* | 888800 | No function |
| | | | 1 | 888YES | All function codes are set to the values marked with * |
| F1 | COUNT8 | Counter Mode of Operation | 0* | 00000 | Input A: Subtracting, Input B: Gate/Inhibit, Input C: Reset |
| | | | 1 | 00000 | Count Input, Directional input, Reset |
| | | | 2 | 00000 | Count Input, Directional input, Gate/Inhibit |
| | | | 3 | 88500 | Adding, Subtracting, Reset |
| | | | 4 | 88500 | Adding, Subtracting, Reset |

9 Batch Counter

| | | | | | | | |
|----|--------|--|----|--------|----------------------|-----------|--------------|
| | | | 5 | 888888 | Adding | Adding | Reset |
| | | | 6 | 908888 | Channel A | Channel B | Reset |
| | | | 7 | 908880 | Channel A | Channel B | Gate/Inhibit |
| F2 | 908888 | Edge Evaluation Quadrat. Evaluation | 0* | 888881 | Single evaluation | | |
| | | | 1 | 888882 | Double evaluation | | |
| | | | 2 | 888884 | Quadruple evaluation | | |
| F3 | 888880 | PNP/ NPN-Logic | 0 | 000008 | NPN 8 V-Level | | |
| | | | 1* | 000008 | PNP 8 V-Level | | |

9 Batch Counter

| | | | | | | | |
|----|--------|--------------------------|----|--------|---|--|--|
| | | | 2 | 000008 | NPN TTL-Level | | |
| | | | 3 | 000008 | PNP TTL-Level | | |
| F4 | 888888 | Input damping (Attenuat) | 0 | 088889 | 30 Hz damping (e.g. for mechanical contacts) | | |
| | | | 1* | 888889 | F max. (see chapter 4 and 10) | | |
| F5 | 058888 | Set / Re-set- Mode | 0* | 888800 | Reset to 0 | | |
| | | | 1 | 888800 | Automatic reset to 0 when Preset value 2 is reached | | |
| | | | 2 | 588882 | Sets to Preset value 2 | | |
| | | | 3 | 888882 | Automatic setting to Preset 2 after reaching 0 | | |

9 Batch Counter

| | | | | | |
|-----|-------------|-----------------------------|----|-------------|---|
| F6 | 8.8.8.8.8.8 | Dynamic/ static Reset | 0* | 5.8.8.8.8.8 | Static Reset (reset as long signal is applied) |
| | | | 1 | 8.8.8.8.8.8 | Dynamic Reset (ready for counting after reset, even if reset signal has been applied for a longer time) |
| F9 | 0.0.8.8.8.0 | Output signal | 0* | 8.8.8.8.0.8 | Active On |
| | | | 1 | 8.8.8.0.0.8 | Active Off |
| F10 | 5.8.8.8.8.0 | Signal time P 0 | 0 | 8.8.8.8.8.8 | Disabled / no output signal |
| | | | 1 | 8.8.8.8.8.8 | Latching; reset with Preset 2 or Reset |
| | | | 2 | 8.8.8.0.0.2 | 0.02 s |
| | | | 3 | 8.8.8.0.0.5 | 0.05 s |

9 Batch Counter

| | | |
|----|-------------|-----------------------------|
| 4* | 8.8.8.0.1.0 | 0.10 s |
| 5 | 8.8.8.0.2.0 | 0.20 s |
| 6 | 8.8.8.0.5.0 | 0.50 s |
| 7 | 8.8.8.1.0.0 | 1.00 s |
| 8 | 8.8.8.2.0.0 | 2.00 s |
| 9 | 8.8.8.5.0.0 | 5.00 s |
| 10 | 8.8.8.0.0.0 | 10.00 s |
| 11 | 0.5.8.8.8.8 | User-setting 1 (0-599.99 s) |

9 Batch Counter

| | | | | | |
|-----|--------|-----------------------------|----|---------|-----------------------------|
| | | | 12 | 0500.02 | User-setting 2 (0-599.99 s) |
| | | | 13 | 0500.03 | User-setting 3 (0-599.99 s) |
| F11 | 500000 | Signal time P1 Batch-Preset | 0 | 005000 | Disabled / no output signal |
| | | | 1 | 615000 | Latching; reset with Reset |
| | | | 2 | 0000.02 | 0.02 s |
| | | | 3 | 0000.05 | 0.05 s |
| | | | 4* | 0000.10 | 0.10 s |
| | | | 5 | 0000.20 | 0.20 s |

9 Batch Counter

| | | | | | |
|--|--|--|----|---------|-----------------------------|
| | | | 6 | 0000.50 | 0.50 s |
| | | | 7 | 0001.00 | 1.00 s |
| | | | 8 | 0002.00 | 2.00 s |
| | | | 9 | 0005.00 | 5.00 s |
| | | | 10 | 0010.00 | 10.00 s |
| | | | 11 | 0500.00 | User-setting 1 (0-599.99 s) |
| | | | 12 | 0500.02 | User-setting 2 (0-599.99 s) |
| | | | 13 | 0500.03 | User-setting 3 (0-599.99 s) |

9 Batch Counter

| F12 | 580822 | Signal time P2 | 0 | 885860 | Disabled / no output signal |
|-----|--------|----------------|----|--------|---|
| | | | 1 | 885888 | Latching; reset with Reset Cannot be used in connection with automatic Reset |
| | | | 2 | 888002 | 0.02 s |
| | | | 3 | 888005 | 0.05 s |
| | | | 4* | 888010 | 0.10 s |
| | | | 5 | 888020 | 0.20 s |
| | | | 6 | 888050 | 0.50 s |
| | | | 7 | 888100 | 1.00 s |

9 Batch Counter

| | | | | | |
|--|--|--|----|--------|-----------------------------|
| | | | 8 | 888200 | 2.00 s |
| | | | 9 | 888500 | 5.00 s |
| | | | 10 | 888000 | 10.00 s |
| | | | 11 | U5E088 | User-setting 1 (0-599.99 s) |
| | | | 12 | U5E082 | User-setting 2 (0-599.99 s) |
| | | | 13 | U5E083 | User-setting 3 (0-599.99 s) |

| F13 | 888888 | Decimal point | 0* | 888880 | No decimal point |
|-----|--------|---------------|----|--------|------------------|
| | | | 1 | 888800 | 1 decimal place |

9 Batch Counter

| | | | | | |
|-----|---------|-----------------|----|------------|---------------------------------|
| | | | 2 | 8.8.8.0.00 | 2 decimal places |
| | | | 3 | 8.8.0.0.00 | 3 decimal places |
| | | | 4 | 8.0.0.0.00 | 4 decimal places |
| F14 | 8.FLASH | Display flashes | 0* | 0.0.0.0.00 | Do not flash |
| | | | 1 | 8.8.8.8.P0 | Flashes as long as P0 is active |
| | | | 2 | 8.8.8.8.P1 | Flashes as long as P1 is active |
| | | | 3 | 8.8.8.8.P2 | Flashes as long as P2 is active |
| | | | 4 | P0.0.0.0.0 | Flashes if any Preset is active |

9 Batch Counter

| | | | | | |
|-----|------------|-----------------------------|----|------------|-------------------------------|
| F15 | 2.8.0.0.8E | 2 nd row display | 0 | 8.8.8.8.P0 | Preset 0 |
| | | | 1 | 8.8.8.8.P1 | Preset 1 |
| | | | 2* | 8.8.8.8.P2 | Preset 2 |
| | | | 3 | 8.8.8.P50 | Prescaler |
| | | | 4 | 6.8.8.8.20 | Batch counter or 2nd counter |
| F16 | 8.8.8.8.8 | External Reset signal | 0 | 8.8.8.8.8 | Only resets the counter |
| | | | 1 | 8.8.8.8.8 | Only resets the batch counter |
| | | | 2* | 8.8.8.8.8 | Resets all counters |

9 Batch Counter

| | | | | | |
|-----|--------|--------------------------------|----|--------|--|
| F17 | P0N0E5 | Power On Reset | 0* | 0880E5 | Restores the counter value |
| | | | 1 | 8880E5 | Reset at Power On |
| F18 | 0VENE0 | Output signal-Memory | 0 | 8884E5 | Restart signal time after power fail  output switches |
| | | | 1* | 888800 | Do not restart signal time after power fail |
| F19 | 68E2H0 | Batch-Counter or 2nd totalizer | 0* | 68E2H0 | Batch counter |
| | | | 1 | 2802E8 | 2nd totalizer |
| F22 | 880000 | Application input/output | 0 | 850000 | Prescaler output |
| | | | 1 | 800000 | Output Preset 0 |

9 Batch Counter

| | | |
|----|--------|--|
| 2 | 800000 | Directional count output |
| 3* | 08E800 | Count input, adding |
| 4 | 08E800 | Count input, subtracting |
| 5 | 0E5800 | Reset counter and Batch counter or 2nd totalizer |
| 6 | 0E5000 | Resets only counter |
| 7 | 0E5800 | Resets only Batch counter or 2nd totalizer |
| 8 | 08E000 | Gate/Inhibit input |
| 9 | 000000 | Keylock input |

9 Batch Counter

| | | |
|----|---------------|------------------------------------|
| 10 | H 0 0 0 0 0 0 | Hold input (display memory) |
| 11 | T E A C H 0 | Teach input Count value becomes P2 |
| 12 | S E E 0 0 0 0 | Set-input (sets to Preset 0) |



F24 - F27 are applicable to multifunction counters with a USB or Ethernet interface. Consult the supplement included with those versions.

| | | | | | |
|-----|---------------|-----------------|----|-------------|---------------------------------|
| F30 | E E S 0 0 0 0 | Lock Re-set key | 0* | 0 0 0 0 0 0 | Keyboard reset enabled |
| | | | 1 | 0 0 0 0 0 0 | Keyboard reset locked / delayed |

| | | | | | |
|-----|---------------|-----------------------|----|-------------|-----------------------------|
| F31 | P 0 0 0 0 0 0 | Lock Preset 0 Setting | 0* | 0 0 0 0 0 0 | P0 Setting enabled |
| | | | 1 | 0 0 0 0 0 0 | P0 Setting locked / delayed |

9 Batch Counter

| | | | | | |
|-----|---------------|-----------------------|----|-------------|-----------------------------|
| F32 | P 1 0 0 0 0 0 | Lock Preset 1 Setting | 0* | 0 0 0 0 0 0 | P1 Setting enabled |
| | | | 1 | 0 0 0 0 0 0 | P1 Setting locked / delayed |

| | | | | | |
|-----|---------------|-----------------------|----|-------------|-----------------------------|
| F33 | P 2 0 0 0 0 0 | Lock Preset 2 Setting | 0* | 0 0 0 0 0 0 | P2 Setting enabled |
| | | | 1 | 0 0 0 0 0 0 | P2 Setting locked / delayed |

| | | | | | |
|-----|---------------|------------------------|----|-------------|------------------------------|
| F34 | P S 0 0 0 0 0 | Lock Prescaler Setting | 0* | 0 0 0 0 0 0 | PSC Setting enabled |
| | | | 1 | 0 0 0 0 0 0 | PSC Setting locked / delayed |

| | | | | | |
|-----|-------------|-----------|----|-------------|------------------------------------|
| F35 | 0 0 0 0 0 0 | Lock Mode | 0* | 1 0 0 5 0 0 | 10 seconds delay |
| | | | 1 | 0 0 0 0 0 0 | Completely locked |
| | | | 2 | 1 0 0 0 0 0 | Lock mode depends on Keylock input |

10 Technical Data

10 Technical Data

General

| | |
|----------------------------|---|
| Display | LCD reflective, Transflective Positive: black figures on back lit background Transmissive Negative: white, red or green figures on black background 2 lines, counter reading/presettings 6-digits; decimal point (up to 4 decimals) |
| Digit height | 1st line 9.3 mm = 0.37"; 2nd line 7.2 mm = 0.28" |
| Supply voltage | SELV: 12-30 VDC; protected against polarity reversal SELV: 24 VAC, 50/60 Hz, $\pm 10\%$ 115 VAC; 230 VAC, 50/60 Hz, $\pm 10\%$ 90-260 VAC; 50/60 Hz |
| Current consumption | 12 - 30 VDC < 200 mA, 24 VAC < 250 mA; including sensor supply 115/230 VAC < 50 mA; incl. sensor supply 90 - 260 VAC < 400 mA; incl. sensor supply |
| Power consumption | < 5 W |
| Duty cycle | 100% |
| Overload protection | external fuse DC: 0.16 AT (IEC 127); DC: 0.2 AT (UL 198) 24 VAC: 315 mA T; 230 VAC: 32 mA T; 115 VAC: 63 mA T |

10 Technical Data

| | |
|-------------------------------|---|
| Overload protection | external fuse 230 V, 2,5 mA T |
| Relay output | |
| Sensor supply | Only for AC operation: 12-24 VDC load-dependent; max. 50 mA |
| Storage of values | NV-memory > 10 years |
| Electrical connections | Plug-in screw-type connections / Terminals |
| Cable cross-section | 1...1.5 mm ² with wire-end sleeves |
| Amplitude threshold | < 2 V and > 8 V or < 1 V and > 4 V at TTL-level amplitude max. 40 VDC |
| Active edge | programmable positive for PNP-input, negativ for NPN-input |
| Input resistance | approx. 10 kOhm |
| Count frequency | max. 60 kHz (TTL 15 kHz): single-channel counting max. 60 kHz (TTL 15 kHz): Different. counting and totalizing channel (A+B together) max. 30 kHz (TTL 15 kHz): Quadrature x1 or x2 max. 15 kHz (TTL 15 kHz): Quadrature x4 damped (attenuated) 30 Hz |
| Pulse form | any desired form (at max. frequency square 1:1) |
| Pulse duration min. | 17 ms (30 Hz); 8 μ s (60 kHz) |
| Prescaler | 0.0001 - 99.9999 |
| Reset | manual reset via keyboard, external reset static or dynamic programmable; pulse length min. 5 ms, |

10 Technical Data

| | |
|------------------------------------|--|
| | automatic reset after reaching Preset 2, (No pulse losses at max. counter frequency due to automatic reset function). via application input (programmable) and programmable Power-On Reset |
| Set function | Setting to Preset 0 (independent of reset) |
| Display and Preset Range | - 999 999 up to + 999 999 |
| Warning signal | Display flashes when preset 0, 1 or 2 are active |
| Signal times | 0.01 s to 599.99 s or latching programming; tolerance +/- 10ms; active On or Off |
| Relay Output for P1 and P2 | Change-over contact max. 250 VAC / 30 VDC / 5 A Change-over contact min. 5 VAC / 5 VDC / 10 mA delay < 10 ms |
| Transistor Output for P1 and P2 | PNP-output 12 - 30 VDC max. 50 mA at DC-supply 12 - 24 VDC max. 30 mA at AC-supply (24/115/230 VAC) 12 - 24 VDC, max 50 mA at AC-supply with switching power supply |
| Application Output | PNP-output 12 - 30 VDC max. 20 mA at DC supply 12 - 24 VDC max. 20 mA at AC supply (24/115/230 VAC) |



Current load of the outputs (Sensor 12-24 VDC, Out 1, Out 2, Application-Output) is not allowed to exceed 65 mA in sum.

10 Technical Data

Counter

| | |
|--|--|
| Counter mode of operation Input A,B | Unidirectional; adding or subtracting; directional input; Differential operation, add / sub; Summation (Totalizing) add / add; Quadrature x1; x2 or x4 |
| Control Input | Reset; Gate/Inhibit |
| Preselect Mode | Absolute or trail, Range signal /limit values (signal 1 < P1, signal 2 > P2) |
| Application Input/Output | Output: Prescaler-out, Preset 0-out, Direction-out Input: addtl. counter input add / sub, Reset, Set, Gate, Keylock, Hold, Teach in |

Batch Counter

| | |
|------|--|
| Mode | Batch counter with Preset or 2nd totalizer with Preset |
|------|--|

Shift Counter

| | |
|---------------------------|---|
| Counter Mode of Operation | Differential counting add/sub, totalizing add/add |
|---------------------------|---|

Tachometer

| | |
|---------------------|------------------------------------|
| Measuring Principle | Period (cycle) measurement (1/Tau) |
| Time base | 1/min or 1/s |

10 Technical Data

| | |
|-------------------------------------|--|
| Min. frequency | 1 Hz or 0.1 Hz |
| Limit values | 2 alarms with programmable startup suppression + 1 additional upper limit value on the application output |
| Tachometer mode of operation | Unidirectional add oder sub; directional input; Differential add / sub; totalizing add / add; Quadrature x1; x2 or x4 A / B or (A-B) / A % |
| Application Input/Output | Output: Preselect 0-out, Direction-out Input: addtl. counter input add / sub, Keylock, Hold, Teach in |
| Accuracy of the tachometer function | Time base: ± 30 ppm Measuring principle: Periodic measurement Measuring time: min. 0.5s / max. 1s oder 10s Measuring resolution: 0.4 μ s (<30 ppm) Display resolution: 4 decimal places, 1 Digit = 100 ppm |
| Overall tolerance | = Shown resolution + tolerance of timebase = 130 ppm |

Timer

| | |
|---------------------|---|
| Measuring Principle | Pulse-width or cycle duration measurement Start Inp. A + Stop Inp. B; Start/Stop key |
| Time base | Programmable in sec, min, h or hh.mm.ss |
| Resolution | 1; 0.1; 0.01; 0.001; 0.0001 |

10 Technical Data

| | |
|--------------------------|--|
| Function | Single-pulse or cumulative measurement |
| Application Input/Output | Output: Preselect 0-out Input: addtl. Run, Stop, Reset, Set, Keylock, Hold, Teach in |
| Accuracy of the timer | Time base: ± 30 ppm Start / Stop-point in time: 16 μ s / 16 ms (not damped / damped) Resolution: 100 μ s = 100 ppm |
| Total tolerance | = Shown resolution + tolerance of timebase = 130 ppm |

Environment. cond. Safety Rules

| | |
|-----------------------------|---|
| General design | EN 61 010 / IEC 61010-1 |
| Protection Class | II; EN 61010-1 / IEC 61010-1 |
| Pollution degree | V 2, EN 50178 |
| EMC - Interference immunity | EN 61326-1 industrial environment * |
| EMC - Emission | EN 61326-1 Class B * |
| Ambient temperature | 0°C - 50°C (32 - 122 F) EN 60 068-2-1/2 |
| Storage temperature | - 20°... + 65°C (-4 - 149 F) EN 60 068-2-1/2 |
| Climate | 40°C (104 F) / 93% rel hum. class 4K4H, EN 60 068-2-78 25 - 50°C (77 - 122 F) / 93% rel hum., cyclic, EN 60 068-2-38 |
| Degree of protection | IP 65 front side; EN 60529 |

10 Technical Data

| | |
|-------------------------|---|
| | IP 20 terminals |
| Vibration resistance | 10 m/s ² (32.8 ft/s ²) (10 ... 150 Hz); IEC 60 068-2-6 |
| Shock resistance | 100 m/s ² (328 ft/s ²) (18 ms); IEC 60 068-2-27 |
| Resistance to chemicals | Frontfoil acc. to DIN 42 115-2 |
| Approvals | UL, CSA; File No.: E 338588 |
| RoHS | compliant |

Mechanical Data

| | |
|--------------------|---|
| Installation | Front-panel installation with tenter (frame) Front panel thickness max. 11 mm (0.43 ") |
| Dimensions | 48 mm x 48 mm x 118 mm (1.89 " x 1.89 " x 4.65 "), installation depth 110 mm (4.33 ") DIN 43700 |
| Front-panel cutout | 45 mm x 45 mm + 0.3 mm (1.77 " x 1.77 " x 0.01 ") |
| Weight | approx. 200 g (7 oz) |

* For cable length > 30 m, for connection to a DC-supply-network and input level TTL an additional protection circuit is necessary.

11 Transport, Packaging, Storage / 12 Maintenance and cleaning

11 Transport, Packaging, Storage



**Note! Damage may be caused by improper transport!
Improper transport may cause considerable damage.
Do not remove packaging before assembly and installation.**

The packaging offers protection against mechanical damage and loss of parts such as the plugs or operating instructions. Therefore, do not take the multifunctional counter out of its packaging until you actually have to start your assembly and installation work.

Inspect the shipment for completeness and possible signs of transport damage immediately after receipt.

12 Maintenance and cleaning

The multifunction counter does not require any maintenance.

The front side may be cleaned with commercially available household detergents.

For additional environmental protection, a flexible transparent face plate protector is available as an accessory

13 Trouble shooting

13 Trouble shooting



Warning!

Improper fault correction may cause serious damage or personal injury.

The machine/plant manufacturer is responsible for the preparation of operating instructions and troubleshooting protocols in the event of malfunctions. This is dependent on the end use design and application.

The first step is to determine if the cause of an error or malfunction implies a possible fault of the multifunction counter.

Possible of Errors

| Error | Possible cause | To be corrected by: |
|-----------------------------------|---|-----------------------|
| Display remains dark | Machine/plant not powered on | Operator |
| Value is not stored | Defective voltage supply | Qualified electrician |
| | Power-on reset is active (F17) | Skilled personnel |
| Counter/tachometer does not count | Defective signal generator; Counter does not receive any counting signals | Skilled personnel |

13 Malfunctions

| | | |
|--|---|-----------------------|
| Counter/tachometer does not count | Adjusted to incorrect mode of operation (F1), Single-channel, directional input, differential counting, phase discriminator | Skilled personnel |
| | Incorrect adjustment of PNP/NPN logic and input level (F3) | Skilled personnel |
| | High-level does not exceed the upper amplitude threshold; low-level does not fall below the lower amplitude threshold | Qualified electrician |
| | Continuous reset signal is applied | Qualified electrician |
| | Continuous gate/inhibit signal is applied | Qualified electrician |
| Incorrect counting of counter/tachometer | Prescaler value is not correct | Skilled personnel |
| | Phase discriminator - edge evaluation not correctly adjusted (F2) | Skilled personnel |
| | Input frequency too high (F4) | Skilled personnel |
| Keyboard Reset not possible | Keys are locked (F30 + F35) | Skilled personnel |
| Presetting not possible | Keys are locked (F31, F32, F33 + F35) | Skilled personnel |
| Prescaler adjustment not possible | Keys are locked (F34+ F35) | Skilled personnel |

14 Spare Parts / 15 Dismantling and Disposal

| | | |
|-------------------------------|------------------------------------|-------------------|
| Signal 0, 1 or 2 not received | Signal deactivated (F10, F11, F12) | Skilled personnel |
| | User signal time adjusted to 0,000 | Skilled personnel |

14 Spare Parts



Warning!
Use only OEM spare parts!

The use of incorrect or faulty spare parts may cause damage, malfunction or safety hazards. Therefore, use only spare parts provided by the OEM.

The multifunction counter may only be opened and serviced by the manufacturer.
Only external components are available as spare parts.

15 Dismantling and Disposal

After reaching the end of its useful life the multifunction counter has to be disposed of or recycled according to applicable local environmental laws.

16 Model Numbers

16 Model Numbers

| Display | Relay | 12-24 VDC | 24 VAC | 115 VAC | 230 VAC | 90-260 VAC* |
|---------------------------|-------|------------|------------|------------|------------|-------------|
| LCD reflective | 1 | VC 0772101 | VC 0772111 | VC 0772121 | VC 0772131 | VC 0772141 |
| LCD reflective | 2 | VC 0772102 | VC 0772112 | VC 0772122 | VC 0772132 | VC 0772142 |
| LCD transfective positive | 1 | VC 0772201 | - | - | - | VC 0772241 |
| LCD transfective positive | 2 | VC 0772202 | - | - | - | VC 0772242 |
| LCD transmissive negative | 1 | VC 0772301 | - | - | - | VC 0772341 |
| LCD transmissive negative | 2 | VC 0772302 | - | - | - | VC 0772342 |
| LCD transmissive red | 1 | VC 0772401 | - | - | - | VC 0772441 |
| LCD transmissive red | 2 | VC 0772402 | - | - | - | VC 0772442 |
| LCD transmissive green | 1 | VC 0772501 | - | - | - | VC 0772541 |
| LCD transmissive green | 2 | VC 0772502 | - | - | - | VC 0772542 |

Transfective Positive: black figures on back lit background
 Transmissive Negative: white figures on black background
 Transmissive red: red figures on black background
 Transmissive green: green figures on black background
 *not yet available

17 Accessories and spare parts

17 Accessories

| Panael Adapter | Item no. | Dimensions | Front panel cutout |
|------------------|-----------|-----------------------------|---|
| | 1 405 675 | 60 x 75 mm (2.36 x 2.95 ") | 55 x 55 mm (2.17 x 2.17 ") |
| | 1 405 676 | 72 x 72 mm (2.83 x 2.83 ") | 68 x 68 mm (2.68 x 2.68 ") |
| | 1 405 679 | 125 x 60 mm (4.92 x 2.36 ") | 106 x 55 mm (4.17 x 2.17 ") for installation of 2 counters |
| Protective Cover | 2 772 052 | | 48 x 48 mm (1.89 x 1.89 ") |
| Frame | 1 721 014 | 48 x 48 mm (1.89 x 1.89 ") | |

Version: 1 190410CB1



02772058



Danaher Controls | 2100 West Broad Street
Elizabethtown NC, 28337 | (0800) 390-6405

A Company of  **DANAHER**
SENSORS & CONTROLS